

CATALOG



AFC

CABLE SYSTEMS®

ARMORED CABLES PRODUCT CATALOG

AC, HCF and MC Cables • MC-Quik® & MC-Stat® Cables • Specialty Application Cables

A PART OF



atkore

INTERNATIONAL

AFC Cable Systems: the Cable Industry Leader for Over 80 Years

AFC Cable Systems, Inc. is proud to announce the launch of two new Type MC cables, MC-Quik and MC-Stat. These two new cables offer the fastest installation times, the least post-installation clean up, and color coding for safety and quick cable identification.

“It's a Snap Without the Wrap” because MC-Quik and MC-Stat feature a polypropylene covering around each insulated conductor, versus the traditional overall wrap around the entire conductor bundle.

The protective covering also replaces the paper wrap found in standard Type AC cables. This change along with the introduction of a full-sized aluminum ground wire plus armor equipment grounding means has brought to the electrical industry the latest technological advances to Type MC cable design.

MC-Quik may be used anywhere traditional Type MC cables have been used, installed to NEC® 330 and manufactured to UL 1569. This cable has a unique purple color denoting that it is MC-Quik with an armor-full sized ground wire equipment grounding means (MCI-A). The additional color bands on the cable armor display the phase and neutral colors of the conductors inside. As we've said for years, “the outside colors tell you the inside story” - that has never been more true than now with the inclusion of neutral conductor colors on the armor.

MC-Stat is our new Type MC cable for health care wiring applications. MC-Stat may be used anywhere traditional Type HCF cables have been used. Within areas of patient care as noted in NEC® 517, MC-Stat qualifies for sensitive installations with an armor and full sized aluminum ground wire combination, plus a full sized green insulated grounding conductor for the second path to equipment grounding. MC-Stat is the right prescription with a bright green color coding denoting health care wiring and additional color bands for phase and neutral identification.

The new AFC cable catalog brings you all the installation instructions you need for either MCI-A (MC-Quik and MC-Stat) cables or traditional Type MC and Type AC cables. And, this new catalog has the complete ordering information you need, as well as a MSDS sheet and NEC® and UL references and specifications.

AFC Cable Systems, Inc. where the union of tradition, technology and innovation blend with the art and science of manufacturing - your electrical industry partner for over 80 years!

Call us at 800-757-6996 or at www.afcweb.com



Other Brands to Serve You



Conduit Systems	Cable Systems	Framing Systems	Cable Tray Systems
<p>Steel Conduit</p> <ul style="list-style-type: none"> • Rigid (GRC) • IMC <p>Aluminum Conduit</p> <ul style="list-style-type: none"> • Rigid • Aluminum Elbows • Aluminum Couplings <p>Steel EMT</p> <ul style="list-style-type: none"> • True Color™ EMT • Fire Alarm™ & Blue EMT • E-Z Pull™ EMT <p>Kwik Products</p> <ul style="list-style-type: none"> • Kwik-Fit™ EMT (built-in set-screw coupling) • Kwik-Couple™ IMC/GRC (built-in 3 piece rotating coupling) • Kwik-Fit™ Compression EMT (built-in compression fitting) <p>PVC</p> <ul style="list-style-type: none"> • Rigid PVC • Schedule - 40 & 80 Products • EB/DB Duct • Fittings, Spacers & Accessories 	<p>AC & MC Cable</p> <ul style="list-style-type: none"> • MC TUFF™ Lightweight Steel (MC) Cable • MC TUFF™ IG (MC) Cable with Isolated Ground • MC Lite™ Metal Clad Aluminum (MC) Cable • MC-Quik™ (MC) Cable • MC-Stat™ (MC) Cable • MC-Plus™ (MC) Cable • HCF-90™ & HCF-Lite™ • AC-90™ & AC-Lite™ • Fire Alarm™ Cable • Home Run Cable™ • Parking Deck/Lot Cable™ • Super Neutral Cable™ <p>Flexible Conduit</p> <ul style="list-style-type: none"> • LIQUID-TUFF™ Liquid-Tight Flexible Conduit • Full and Reduced Wall Flexible Metal Conduit <p>Fittings</p> <ul style="list-style-type: none"> • EMT Steel Compression & Set-Screw Fittings • Liquid-Tight Metallic & Non-Metallic Fittings • MC/AC Cable Connectors <p>AFC Accessories</p> <ul style="list-style-type: none"> • Light, Power, & Appliance Whips • Temp-Lites™ • Bare Armored Ground 	<p>Channel</p> <ul style="list-style-type: none"> • Steel Channel • Aluminum Channel • Stainless Steel Channel • Fiberglass Channel • Junior Channel <p>Fittings & Accessories</p> <ul style="list-style-type: none"> • Channel Brackets • Channel Fittings • Pipe Clamps • Threaded Rods • Fiberglass Fittings • Junior Channel Fittings • Concrete Inserts • Slotted Angles <p>Finishes</p> <ul style="list-style-type: none"> • Pre-Galvanized Channel • Green Channel • Hot-Dip Galv. Channel • Gold Channel <p>Solar Products</p>	<p>Aluminum Tray</p> <ul style="list-style-type: none"> • Aluminum Ladder Tray • Aluminum Hat Tray • Aluminum Trof Tray • Aluminum Channel • Aluminum Fittings <p>Steel Tray</p> <ul style="list-style-type: none"> • Steel Ladder Tray • Steel Hat Tray • Steel Trof Tray • Steel Channel • Steel Fittings <p>I-Beam™ Cable Tray</p> <ul style="list-style-type: none"> • I-BEAM™ Aluminum Tray • I-BEAM™ Accessories <p>Fiberglass Tray</p> <ul style="list-style-type: none"> • Cope-glas™ Fiberglass Tray • Fiberglass Fittings <p>Center Hung Tray</p> <ul style="list-style-type: none"> • Centipede™ Tray • Centipede™ Accessories <p>Other Cope Products</p> <ul style="list-style-type: none"> • Cable Channel
<p>Columbia-MBF™</p> <p>Conduit Systems Canada</p>	<p>ACS/Uni-Fab™</p> <p>Modular Wiring Systems</p>	<p>UNISTRUT™</p> <p>Framing Systems</p>	<p>ACROBA™</p> <p>Basket Tray Systems</p>
<p>All items listed above, except for the following:</p> <ul style="list-style-type: none"> • IMC • Kwik-Couple IMC • PVC 	<p>ACS/Uni-Fab</p> <ul style="list-style-type: none"> • Modular Lighting Systems • Raised Floor Assemblies • Pre-Fab Assemblies 	<p>All items listed above, plus the following:</p> <p>Gratings</p> <p>Roof Walks</p> <p>Solar Products</p> <p>Telestrut™ Telescoping Strut System</p> <p>UniPier® Rooftop Supports</p>	<p>Acroba Wire Basket</p> <ul style="list-style-type: none"> • Wire Basket Tray • Wire Basket Accessories



AFC
CABLE SYSTEMS®

A PART OF **Atkore**
INTERNATIONAL



Table of Contents	1
UL Compliance and Factory Locations	2
MC Product Summaries	3 - 9
MCI-A Type MC Metal Clad Cables	
Specifications	
MC-Quik® Steel Metal Clad Cable (120/208V & 480Y/277V)	10
MC-Quik® Lite Aluminum Metal Clad Cable (120/208V & 480Y/277V)	11
MC-Stat® Steel Metal Clad Cable (120/208V & 480Y/277V)	12
MC-Stat® Lite Aluminum Metal Clad Cable (120/208V & 480Y/277V)	12
MC-Stat® Plus Steel Metal Clad Cable (120/208V & 480Y/277V)	13
MC-Stat® Plus Lite Aluminum Metal Clad Cable (120/208V & 480Y/277V)	13
MC-Quik® and MC-Stat® Metal Clad Cable Installation Instructions	14 - 15
MC Metal Clad Cables	
Specifications	
MC TUFF® Lightweight Steel Metal Clad Cable (120/208V colors)	16
MC TUFF® Lightweight Steel Metal Clad Cable (480Y/277V colors)	17
Type MC Steel Cable (8 AWG - 2 — 4/0 AWG - 4)	18
MC Lite® Metal Clad Aluminum Cable (120/208V & 480Y/277V colors) no Stripes	19
MC Lite® Metal Clad Aluminum Cable (120/208V colors) with Stripes	20
MC Lite® Metal Clad Aluminum Cable (480Y/277V colors) with Stripes	21
MC TUFF® IG Isolated Ground Lightweight Steel Metal Clad Cable	22
MC Lite® IG Isolated Ground Lightweight Aluminum Metal Clad Cable	23
MC-Plus® Neutral per Phase and Oversized Neutral Cable	24
Super Neutral Cable® Metal Clad Cable	25
Parking Deck/Lot Cable™ PVC Jacketed Metal Clad Cable	26
Home Run Cable® Metal Clad Cable	27
Fire Alarm® Control Cable Metal Clad Cable	28
Fire Alarm® Control Cable Performance Chart	29
Introduction to Type AC Armored Cables	30
AC Product Summaries	31
AC & HCF Armored Cables	
Specifications	
AC-90® Steel Armored Cable (120/208V colors)	32
AC-90® Steel Armored Cable (480Y/277V colors)	32
AC-Lite® Aluminum Armored Cable (120/208V conductor colors) Plain Armor, No Stripes	33
AC-Lite® Aluminum Armored Cable (480Y/277V colors)	33
HCF-90® Steel Health Care Facilities Cable (120/208V colors)	34
HCF-90® Steel Health Care Facilities Cable (480Y/277V colors)	34
HCF-Lite® Aluminum Health Care Facilities Cable (120/208V colors)	35
HCF-Lite® Aluminum Health Care Facilities Cable (480Y/277V colors)	35
NEC® Code References	36
Comparison Chart of MC, AC & HCF Cables	37-38
Bare Armored Ground Cables	39
Metallic Whips	40
Non-Metallic Whips	41
MSDS	42
Installation Instructions	43-45
MC & AC Connector Cross-Reference Guide	46-47
MCI-A Connector Cross-Reference Guide	48-53
Metallic/Non-Metallic and Parking Deck/Lot Raintight Cable™ Connectors	54-55
AFC's Custom Armoring Options	56
Note: Made in USA of US and/or imported materials	



AFC products Type AC, Type HCF, Type MC, Liquid-tight and Flexible Metal Conduits, are fabricated in the continental US to the applicable UL standards.

Cables are manufactured in compliance with UL standards: Type MC cables are UL listed and manufactured in compliance with UL 1569, listing file E 80042. Type AC cables are UL listed and manufactured in compliance with UL 4, listing file E 7330.

Liquid-tight products that are UL listed are manufactured in compliance with UL standards, UL 360 for metallic products and UL 1660 for non-metallic products. Metallic conduits that are UL listed are included in listing file E26540. Non-metallic conduits that are UL listed are listing file E 123464, and CSA certified under file LL69271.

Flexible Metal Conduits that are UL listed are manufactured in compliance with UL 1 and listing under UL File E 11831 and CSA File Number 15035.

AFC's Fittings products are not manufactured in the continental US but are manufactured at an AFC UL certified facility to the applicable standard UL 514-B.

Our US manufacturing facilities are located in New Bedford, Massachusetts; Byesville and Cambridge, Ohio; Largo, Florida and Fullerton, California.

*For technical questions contact -
TechnicalServices@afcmail.com or call 508-985-1277 or 877-843-4870*

AFC Cable Systems
272 Duchaine Blvd, New Bedford, MA 02745
Tel: 508-998-1131
800-757-6996
Fax: 508-998-1447

www.afcweb.com

Introduction

Type MC Cables

Type MC Metal Clad Cables – Uses Permitted:

The uses permitted for MC cable are governed by NEC® Article 330 and any applicable local codes. Please refer to NEC® Article 330 and your local authority having jurisdiction for additional information.

- **Where not subject to physical damage;
For services, feeders and branch circuits**
- **For power, lighting, control and signal circuits**
- **Indoors, exposed or concealed**
- **Outdoors or in wet locations where the armor has an overall outer moisture resistant PVC jacket and the conductors are wet rated (Parking Deck/Lot Cable™)**
- **Direct buried or in concrete encasement where identified for such use (Parking Deck/Lot Cable™)**
- **Under raised floors, above suspended ceilings and in other environmental air-handling spaces per NEC® 300.22(C)**
- **In Places of Assembly**
- **In cable tray or as open runs**
- **In locations classified as hazardous as permitted in NEC® Articles 501, 502, 503, 504, 505, and 530**
- **As aerial cable on a messenger**
- **MC-Stat® (only) NEC® 517**
- **Aluminum armored cables are RoHS Compliant**
- **Made in USA of US and/or imported materials**

Type MC Cables – Uses Not Permitted:

- **Where exposed to destructive corrosive conditions unless the metallic sheath is suitable for the conditions or is protected by material suitable for the conditions**

For more information about the proper use and application of AC & MC cables, visit AFC University at www.afcweb.com/afcu.



UL standard 1569 governs the manufacturing of Type MC cables. The standard was updated to include Type MC cables with a ground fault path consisting of an armor and full-sized bare aluminum ground wire, known as MCI-A cables (metal-clad interlocking ground cable). These cables are required to be terminated using connectors UL listed and marked for MCI-A cables (UL 514-B).

AFC's NEW MC-Quik® and MC-Stat® cables are Type MC designed as MCI-A cables. The grounding means of these Type MC cables is the armor plus the full-sized bare aluminum ground wire. MC-Stat also contains a full sized green insulated copper grounding conductor as required by NEC® 517 for areas of patient care. MC-Quik and MC-Stat contain insulated copper circuit conductors with thermoplastic insulation and individual protective coverings versus an overall polypropylene tape. It is available in either galvanized steel or aluminum interlocking armor.

Type MC cables of traditional design will include one or more copper grounding conductors. The armor of these Type MC cables is not an approved equipment grounding means. Traditional Type MC cables consist of copper circuit and grounding conductors with thermoplastic insulation, an overall polypropylene assembly tape and an outer galvanized steel or aluminum interlocking metal armor.

Type MC cables should be cut with an armored cable rotary cutting tool which helps eliminate nicking and cutting of the conductors and removes the metal armor quickly and safely.

AFC's Type MC cables, including the new MCI-A styles and traditional MC styles, display the ColorSpec ID System for fast cable and system voltage identification.

NEC® is a registered trademark of the National Electrical Code®.



MC-Quik® Steel Cable

MCI-A steel armor - Metal Clad Cable (Patent Pending)

New Type MC cable without an overall assembly tape featuring ColorSpec®

Features & Benefits

Interlocking galvanized steel or aluminum armor

Purple armor for easy cable identification

Armor plus full-sized aluminum ground wire is the equipment grounding means

Protective covering over each insulated copper conductor

MCI-A listed connectors required

UL Classified for Through-Wall Penetrations

Made in USA of US and/or imported materials

Applications

Commercial, industrial, multi-residential branch circuits for power, lighting, control and signal circuit.

Exposed or concealed, dry locations, fished, surface mounted, embedded in plaster, environmental air handling spaces, in hazardous locations to Class I & II, Div 2 and Class III, Div. 1 & 2 (per NEC® Articles 501, 502, 503, 530), Places of Assembly per NEC® Article 518.

Product Specifications

MC-Quik® Steel Metal Clad Cable (120/208V colors) & (480Y/277V colors)

Refer to page:

10



MC-Quik® Lite Aluminum Cable

MCI-A aluminum armor - Metal Clad Cable (Patent Pending)

New Type MC cable without an overall assembly tape featuring ColorSpec®

Features & Benefits

Interlocking galvanized steel or aluminum armor

Purple armor for easy cable identification

Armor plus full-sized aluminum ground wire is the equipment grounding means

Protective covering over each insulated copper conductor

MCI-A listed connectors required

UL Classified for Through-Wall Penetrations

Made in USA of US and/or imported materials

Applications

Commercial, industrial, multi-residential branch circuits for power, lighting, control and signal circuit.

Exposed or concealed, dry locations, fished, surface mounted, embedded in plaster, environmental air handling spaces, in hazardous locations to Class I & II, Div 2 and Class III, Div. 1 & 2 (per NEC® Articles 501, 502, 503, 530), Places of Assembly per NEC® Article 518.

Product Specifications

MC-Quik® Aluminum Metal Clad Cable (120/208V colors) & (480Y/277V colors)

Refer to page:

11



MC-Stat® Cable

MCI-A steel armor - Metal Clad Cable (Patent Pending)
New type MC cable for health care applications featuring ColorSpec®

Features & Benefits

- Interlocking galvanized steel armor**
- Green armor for easy cable identification in health care applications**
- Armor plus full-sized aluminum ground wire is the equipment grounding mean, second equipment grounding means is full sized insulated copper grounding conductor**
- MCI-A listed connectors required**
- UL Classified for Through-Wall Penetrations**
- Made in USA of US and/or imported materials**

Applications

Branch circuits in areas of patient care in hospitals, nursing homes, outpatient facilities, dental offices, clinics and medical centers (other than emergency, life safety or critical care locations), Places of Assembly, under raised floors, above suspended ceilings, environmental air-handling spaces, exposed or concealed dry locations, surface mounted, fished, any application requiring isolated or redundant grounding, normal or general purpose power in health care settings. Places of Assembly as per NEC® Article 518, and in Patient Care Areas of Patient Care as per NEC® Article 517.

Product Specifications

MC-Stat® Steel Metal Clad Cable (120/208V colors) & (480Y/277V colors)

Refer to page:
12



MC-Stat® Lite Cable

MCI-A aluminum armor - Metal Clad Cable (Patent Pending)
New type MC cable for health care applications featuring ColorSpec®

Features & Benefits

- Interlocking galvanized aluminum armor**
- Green armor for easy cable identification in health care applications**
- Armor plus full-sized aluminum ground wire is the equipment grounding mean, second equipment grounding means is full sized insulated copper grounding conductor**
- MCI-A listed connectors required**
- UL Classified for Through-Wall Penetrations**
- Made in USA of US and/or imported materials**

Applications

Branch circuits in areas of patient care in hospitals, nursing homes, outpatient facilities, dental offices, clinics and medical centers (other than emergency, life safety or critical care locations), Places of Assembly, under raised floors, above suspended ceilings, environmental air-handling spaces, exposed or concealed dry locations, surface mounted, fished, any application requiring isolated or redundant grounding, normal or general purpose power in health care settings. Places of Assembly as per NEC® Article 518, and in Patient Care Areas of Patient Care as per NEC® Article 517.

Product Specifications

MC-Stat® Lite Aluminum Metal Clad Cable (120/208V colors) & (480Y/277V colors)

Refer to page:
12



MC-Stat® Plus Cable

MCI-A steel or aluminum armor - Metal Clad Cable (Patent Pending)
For health care applications featuring ColorSpec®

Features & Benefits

- A neutral per phase Type MCI-A cable designed for multi-wire branch circuit applications**
- Addresses harmonics distortions in power distribution systems and meets the requirements of NEC® 210.4(B) Disconnecting Means**
- Eliminates shared neutrals, and allows electrical systems to continue to operate**
- Decreases the time it takes to identify a faulty circuit because only the affected single-phase breaker will trip thus, reducing the length of unnecessary outages**
- Type MCI-A cable with a green insulated copper grounding conductor**
- Made in USA of US and/or imported materials**

Applications

Branch circuit wiring for a variety of power distribution systems from lighting, to devices and receptacles. Branch circuit to computers and other electronic equipment where additive harmonics currents from non-linear switching loads may be present

Product Specification

MC-Stat® Plus Cable (120/208V colors)
MC-Stat® Plus Lite Cable (120/208V colors)

Refer to page:
13
13





MC TUFF® Steel MC Cable

Lightweight Steel Metal Clad Cable

High Strength, Lightweight Galvanized Steel Armor featuring ColorSpec®

Features & Benefits

High strength, lightweight interlocking steel armor

Blue armor for easy identification

May be used with set-screw connectors UL listed for use with MC Cable

Superior EMI shielding versus aluminum armor

UL Classified for Through-Wall Penetrations

MC TUFF is a traditional Type MC cable containing one or more copper grounding conductors; the armor is not an equipment grounding means.

Made in USA of US and/or imported materials



Applications

Commercial, industrial, multi-residential branch circuits and feeder wiring-services for power, lighting, control and signal circuits, exposed or concealed, fished, surface mounted, embedded in plaster, environmental air-handling spaces, open or messenger supported aerial runs, dry locations, hazardous locations to Class I & II Div. 2 and Class III, Div. 1 & 2 (per NEC® Articles 501, 502, 503, 530), Places of Assembly, and applications requiring superior EMI shielding

Product Specifications

MC TUFF® Lightweight Steel Metal Clad Cable (120/208V colors)

MC TUFF® Lightweight Steel Metal Clad Cable (480Y/277V colors)

Refer to page:

16

17



Type MC Steel Metal Clad Cable (8 AWG-2 – 4/0 AWG-4)

Galvanized Steel Armor

Features & Benefits

Galvanized interlocking steel armor

May be used with set-screw connectors UL listed for use with MC Cable

Superior EMI shielding versus aluminum armor

UL Classified for Through-Wall Penetrations

Type MC Steel Metal Clad Cable is a traditional Type MC cable containing one or more copper grounding conductors; the armor is not an equipment grounding means.

Made in USA of US and/or imported materials

Applications

Commercial, industrial, multi-residential branch circuits and feeder wiring-services for power, lighting, control and signal circuits. Exposed or concealed, fished, surface mounted, embedded in plaster, environmental air-handling spaces, open or messenger supported aerial runs, dry locations, in hazardous locations to Class I & II Div. 2 and Class III, Div. 1 & 2 (per NEC® Articles 501, 502, 503, 530), Places of Assembly, and applications requiring superior EMI shielding

Product Specifications

Type MC Steel Metal Clad Cable (8 AWG-2 – 4/0 AWG-4)

Refer to page:

18



MC Lite® Metal Clad Cable

Aluminum Interlocking Armor featuring ColorSpec®

Features & Benefits

Aluminum armor with Phase/Circuit Stripes

UL Classified for Through-Wall Penetrations

MC Lite is a traditional Type MC cable containing one or more copper grounding conductors; the armor is not an equipment grounding means

Aluminum armored cables are RoHS Compliant

Made in USA of US and/or imported materials

Applications

Commercial, industrial, multi-residential branch circuits and feeder wiring, services for power, lighting, control and signal circuits. Exposed or concealed, fished, surface mounted, embedded in plaster, environmental air-handling spaces, open or messenger supported aerial runs, dry locations, in hazardous locations to Class I & II Div. 2 and Class III, Div. 1 & 2 (per NEC® Articles 501, 502, 503, 530), and in Places of Assembly

Product Specification

Refer to page:

MC Lite® Metal Clad Aluminum Cable (120/208V and 480Y/277V conductor colors, no stripes)	19
MC Lite® Metal Clad Aluminum Cable (120/208V colors)	20
MC Lite® Metal Clad Aluminum Cable (480Y/277V colors)	21



MC TUFF® IG & MC Lite® IG – Isolated Ground Cable

MC Tuff® Lightweight Blue Interlocking Steel Armored Isolated Ground Cable

MC Lite® Interlocking Silver Aluminum Armored Isolated Ground Cable

Aluminum Armored Cables are RoHS Compliant

Features & Benefits

Ideal where isolated or dedicated grounding is required

High strength, lightweight steel or aluminum armor

Features 2 green grounds, 1 solid green, 1 with yellow stripe

Blue or silver armor with additional green stripe for easy identification

UL Classified for Through-Wall Penetrations

MC Tuff IG & MC Lite IG are traditional Type MC cables; the armor is not an equipment grounding means.

Aluminum armored cables are RoHS Compliant

Made in USA of US and/or imported materials

Applications

Commercial, industrial, multi-residential branch circuits and feeder wiring approved for MC cable requiring isolated, redundant or dedicated grounding conductors, services for power, lighting, control and signal circuits, exposed or concealed, fished, surface mounted, embedded in plaster, environmental air-handling spaces, open or messenger supported aerial runs, dry locations, in hazardous locations to Class I & II Div. 2 and Class III, Div. 1 & 2 (per NEC® Articles 501, 502, 503, 530), and in Places of Assembly

Product Specifications

Refer to page:

MCTUFF® IG Isolated Ground Lightweight Steel Metal Clad Cable	22
MC Lite® IG Metal Clad Aluminum Cable (120/208V colors)	23

* U.S. Patent #38,345 (reissue), 6,825,418 (Phase ID)



MC-Plus® and MC-Plus® Lite Cable

Galvanized Interlocking Steel and/or Aluminum Armor

Features & Benefits

A neutral per phase Type MC cable designed for multi-wire branch circuit applications

Addresses harmonics distortions in power distribution systems and meets the requirements of NEC® 210.4(B) Disconnecting Means

Eliminates shared neutrals, and allows electrical systems to continue to operate

Designed to meet NEC® 210.4(B)

Decreases the time it takes to identify a faulty circuit because only the affected single-phase breaker will trip thus, reducing the length of unnecessary outages

Traditional Type MC cable with a green insulated copper grounding conductor

Aluminum armored cables are RoHS compliant

Made in USA of US and/or imported materials

Applications

Branch circuit wiring for a variety of power distribution systems from lighting, to devices and receptacles. Branch circuit to computers and other electronic equipment where additive harmonics currents from non-linear switching loads may be present

Product Specification

MC-Plus® Cable

Refer to page:

24



Super Neutral Cable®

Galvanized Interlocking Steel or (optional) Aluminum Armor

Features & Benefits

Designed to minimize the effects of harmonic currents on the neutral conductors generated by non-linear loads

Features oversized neutral conductor

Cable designs and conductor color schemes compatible with most modular office furniture

UL Classified for Through-Wall Penetrations

Optional Aluminum armored cables are RoHS Compliant

Made in USA of US and/or imported materials

Applications

Branch circuit and feeder wiring for computers, programmable controllers, electronic discharge lighting, office machines and other electronic equipment that introduce additive harmonic currents from non-linear switching loads, compatible with most modular office furniture, under raised floors, above suspended ceilings, environmental air-handling spaces, and applications requiring superior EMI shielding (steel armor only)

Product Specification

Super Neutral Cable®

Refer to page:

25



Home Run Cable®

Galvanized Steel Armor

Features & Benefits

Home Run Cable® is a traditional Type MC cable containing one or more copper grounding conductors; the armor is not an equipment grounding means

Versatile multi-conductor cable Phase identified by color code with separate marking for circuit identification

UL Classified for Through-Wall Penetrations

Made in USA of US and/or imported materials

Applications

Multi-conductor runs from panel board to junction box for power, lighting, control and signal circuits, also used in repetitive home runs in multi-story hotels, dormitories, commercial office buildings and warehouse applications. Conductors must be derated per NEC® Table 310.15(B)(3)(a), exposed, concealed, or fished, in cable trays and environmental air-handling spaces.

Product Specification

Home Run Cable®

Refer to page:

27



Fire Alarm® Control Cable

Galvanized Interlocking Steel Armor Color Coded Red featuring ColorSpec®

Features & Benefits

RED armor identifies Fire Alarm Cable

Type FPLP or Dual-Rated Type MC/FPLP is plenum rated

Available with twisted shielded pairs

Superior EMI Shielding versus aluminum armor

UL Classified for Through-Wall Penetrations

Fire Alarm/Control Cable is a traditional Type MC cable containing one or more copper grounding conductors; the armor is not an equipment grounding means

Made in USA of US and/or imported materials

Applications

Fire alarm wiring or remote control hook-up connecting main fire alarm control panel with pull stations, smoke detectors and alarms, remote control circuits from magnetic motor starters, contractor, relays and signals, exposed, concealed, in cable trays, ducts, plenums or other environmental air-handling spaces, FPLP, in hazardous locations up to Class I & II, Div. 2 and Class III, Div. 1 & 2 (per NEC® Articles 501, 502, 503, 530).

Product Specification

Fire Alarm® Control Cable

Fire Alarm® Control Cable Performance Chart

Refer to page:

28

29



Parking Deck /Lot Cable™ – PVC Jacketed MC Cable

Galvanized Steel Armor with PVC Jacket

Features & Benefits

Galvanized steel armor with PVC jacket

UL listed for direct burial in earth or concrete encasement

Listed for -40° C low temperature use

UL1569, 70,000 BTU and FT4 vertical tray flame listed

Sunlight and oil resistant with direct plow-in capability

Made in USA of US and/or imported materials

Applications

Branch circuit and feeder wiring for lighting, control and signal circuits in wet, dirty or oily locations, buried directly in earth or concrete, surface mounted or trenched for use in parking deck or parking lot applications, golf courses, ski mountains, docks, marinas, pumping stations and stadium lighting. Also used in continuous runs to outdoor or underground swimming pool motors, pumps and related equipment (per NEC® 680), fished, exposed or concealed cable trays, direct sunlight and hazardous locations up to Class I & II, Div. 2 and Class III, Div. 1 & 2 (NEC® Articles 501, 502, 503, 530).

Product Specification

Parking Deck/Lot Cable™ PVC Jacketed Metal Clad Cable

Refer to page:

26

MC-Quik® Steel Armor Cable – MCI-A Cables (120/208V & 480Y/277V) Technical Specifications



Specification Description

Specification	MC-Quik®
Armor	Galvanized Interlocking Steel Strip (purple striped)
Conductors	Solid/Stranded Copper
Conductor Insulation	Type THHN with protective polypropylene covering on each insulated conductor (no messy assembly tape)
Maximum Temperature Rating	90°C (dry)
Grounding	One grounding means - armor PLUS full-sized aluminum ground/bond conductor NEC® 250.118(10)(b)
Neutral Conductor	White 120/208V - Gray 277/480V
Maximum Voltage Rating	600V

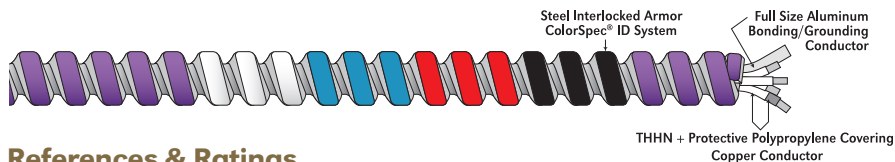

References & Ratings

- UL 1569, UL 83, UL 1479, UL 1581, UL 2556, E80042
- Federal spec A-A-59544 (formerly J-C-30B)
- NEC® 330, 300.22(C), 230.43, 250.118, 392, 396, 501, 502, 503, 530, 518, 520, 645, 690.31(E)
- Permitted for use in Cable Trays
- Meets all OSHA and HUD requirements
- May be surface mounted, fished and/or embedded in plaster
- UL Classified 1, 2, and 3 hour through (Fire) penetration product, R-14141
- NEC® 300.22(C) Environmental Air Handling Spaces
- Cable Tray Rated, install per NEC®
- Patent Pending
- Made in USA of US and/or imported materials



Product Codes, Trade Sizes, Conductors, Packaging & Weights

Product Code No.		Trade Size AWG	Copper Cond. Type	Conductor Colors	Bare Alum. Bonding/Bond Cond. AWG	Cable Nominal O.D. (in)	Approx. Weight 1000 Ft. (lbs.)
250' Coil	1000' Reel						
MC-Quik® Cable							
120/208V solid							
7701-42-00	7701-60-00	14/2	Solid	(black,white)	12	0.422	93
7702-42-00	7702-60-00	14/3	Solid	(black,red, white)	12	0.467	120
7703-42-00	7703-60-00	14/4	Solid	(black, red, blue, white)	12	0.503	144
7704-42-00	7704-60-00	12/2	Solid	(black, white)	10	0.463	122
7704-42-04	7704-60-04	12/2	Solid	(red, white)	10	0.463	122
7704-42-05	7704-60-05	12/2	Solid	(blue, white)	10	0.463	122
7705-42-00	7705-60-00	12/3	Solid	(black, red, white)	10	0.523	159
7705-42-04	7705-60-04	12/3	Solid	(red, blue, white)	10	0.523	159
7705-42-05	7705-60-05	12/3	Solid	(black, blue, white)	10	0.523	159
7706-42-00	7706-60-00	12/4	Solid	(black, red, blue, white)	10	0.565	208
7707-42-00	7707-60-00	10/2	Solid	(black, white)	8	0.525	182
7707-42-04	7707-60-04	10/2	Solid	(red, white)	8	0.525	182
7707-42-05	7707-60-05	10/2	Solid	(blue, white)	8	0.525	182
7708-42-00	7708-60-00	10/3	Solid	(black, red, white)	8	0.601	240
7708-42-04	7708-60-04	10/3	Solid	(red, blue, white)	8	0.601	240
7708-42-05	7708-60-05	10/3	Solid	(blue, black, white)	8	0.601	240
7709-42-00	7709-60-00	10/4	Solid	(black, red, blue, white)	8	0.651	309
120/208V Stranded							
7758-42-00	7758-60-00	12/2	Stranded	(black, white)	10	0.482	127
7759-42-00	7759-60-00	12/3	Stranded	(black, red, white)	10	0.539	166
277/480V Solid							
7704-42-01	7704-60-01	12/2	Solid	(brown, gray)	10	0.463	122
7704-42-02	7704-60-02	12/2	Solid	(orange, gray)	10	0.463	122
7704-42-03	7704-60-03	12/2	Solid	(yellow, gray)	10	0.463	122
7704-42-07	7704-60-07	12/2	Solid	(purple, gray)	10	0.463	122
7705-42-01	7705-60-01	12/3	Solid	(brown, orange, gray)	10	0.523	159
7705-42-02	7705-60-02	12/3	Solid	(orange, yellow, gray)	10	0.523	159
7706-42-01	7706-60-01	12/4	Solid	(brown, orange, yellow, gray)	10	0.565	208
7707-42-01	7707-60-01	10/2	Solid	(brown, gray)	8	0.525	182
7707-42-02	7707-60-02	10/2	Solid	(orange, gray)	8	0.525	182
7707-42-03	7707-60-03	10/2	Solid	(yellow, gray)	8	0.525	182
7707-42-07	7707-60-07	10/2	Solid	(purple, gray)	8	0.525	182
7708-42-01	7708-60-01	10/3	Solid	(brown, orange, gray)	8	0.601	240
7708-42-02	7708-60-02	10/3	Solid	(orange, yellow, gray)	8	0.601	240
7708-42-03	7708-60-03	10/3	Solid	(yellow, brown, gray)	8	0.601	240
7708-42-07	7708-60-07	10/3	Solid	(purple, brown, gray)	8	0.601	240
7709-42-01	7709-60-01	10/4	Solid	(brown, orange, yellow, gray)	8	0.651	309
7709-42-07	7709-60-07	10/4	Solid	(purple, brown, yellow, gray)	8	0.651	309

NOTE: All dimensions and weights are subject to normal manufacturing tolerances.

SEE CONNECTOR MCI-A CROSS-REFERENCE GUIDE FOR ASSISTANCE IN SELECTING AN MCI-A LISTED CONNECTOR.

MC-Quik® Lite Aluminum Armored Cable – MCI-A Cables (120/208V & 480Y/277V) Technical Specifications



Specification Description

Specification	MC-Quik® Lite
Armor	Interlocked Aluminum Strip (purple striped)
Conductors	Solid/Stranded Copper
Conductor Insulation	Type THHN with protective polypropylene covering on each insulated conductor (no messy assembly tape)
Maximum Temperature Rating	90°C (dry)
Grounding	One grounding means - armor PLUS full-sized aluminum ground/bond conductor NEC® 250.118(10)(b)
Neutral Conductor	White 120/208V - Gray 277/480V
Maximum Voltage Rating	600V

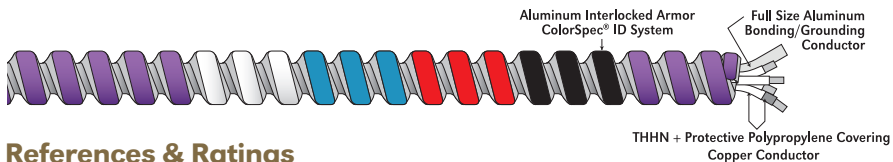

References & Ratings

- UL 1569, UL 83, UL 1479, UL 1581, UL 2556, E80042
- Federal spec A-A-59544 (formerly J-C-30B)
- NEC® 330, 300.22(C), 230.43, 250.118, 392, 396, 501, 502, 503, 530, 518, 520, 645, 690.31(E)
- Permitted for use in Cable Trays
- Meets all OSHA and HUD requirements
- May be surface mounted, fished and/or embedded in plaster
- UL Classified 1, 2, and 3 hour through (Fire) penetration product, R-14141
- NEC® 300.22(C) Environmental Air Handling Spaces
- Cable Tray Rated, install per NEC®
- Patent Pending
- Made in USA of US and/or imported materials



Product Codes, Trade Sizes, Conductors, Packaging & Weights

Product Code No.		Trade Size AWG	Copper Cond. Type	Conductor Colors	Bare Alum. Bonding/Bond Cond. AWG	Cable Nominal O.D. (in)	Approx. Weight 1000 Ft. (lbs.)
250' Coil	1000' Reel						
MC-Quik® Lite Cable							
120/208V Solid							
3101-42-00	3101-60-00	14/2	Solid	(black,white)	12	0.422	66
3102-42-00	3102-60-00	14/3	Solid	(black,red, white)	12	0.467	88
3103-42-00	3103-60-00	14/4	Solid	(black, red, blue, white)	12	0.503	109
3104-42-00	3104-60-00	12/2	Solid	(black, white)	10	0.463	90
3104-42-04	3104-60-04	12/2	Solid	(red, white)	10	0.463	90
3104-42-05	3104-60-05	12/2	Solid	(blue, white)	10	0.463	90
3105-42-00	3105-60-00	12/3	Solid	(black, red, white)	10	0.523	122
3105-42-04	3105-60-04	12/3	Solid	(red, blue, white)	10	0.523	122
3105-42-05	3105-60-05	12/3	Solid	(black, blue, white)	10	0.523	122
3106-42-00	3106-60-00	12/4	Solid	(black, red, blue, white)	10	0.565	151
3107-42-00	3107-60-00	10/2	Solid	(black, white)	8	0.525	131
3108-42-00	3108-60-00	10/3	Solid	(black, red, white)	8	0.601	178
3109-42-00	3109-60-00	10/4	Solid	(black, red, blue, white)	8	0.651	242
277/480V Solid							
3104-42-01	3104-60-01	12/2	Solid	(brown, gray)	10	0.463	90
3104-42-02	3104-60-02	12/2	Solid	(orange, gray)	10	0.463	90
3104-42-03	3104-60-00	12/2	Solid	(yellow, gray)	10	0.463	90
3104-42-07	3104-60-07	12/2	Solid	(purple, gray)	10	0.463	90
3105-42-01	3105-60-01	12/3	Solid	(brown, orange, gray)	10	0.523	122
3106-42-01	3106-60-01	12/4	Solid	(brown, orange, yellow, gray)	10	0.565	151
3107-42-01	3107-60-01	10/2	Solid	(brown, gray)	8	0.525	131
3107-42-02	3107-60-02	10/2	Solid	(orange, gray)	8	0.525	131
3107-42-03	3107-60-03	10/2	Solid	(yellow, gray)	8	0.525	131
3107-42-07	3107-60-07	10/2	Solid	(purple, gray)	8	0.525	131
3108-42-01	3108-60-01	10/3	Solid	(brown, orange, gray)	8	0.601	178
3108-42-02	3108-60-02	10/3	Solid	(orange, yellow, gray)	8	0.601	178
3108-42-03	3108-60-03	10/3	Solid	(yellow, brown, gray)	8	0.601	178
3108-42-07	3108-60-07	10/3	Solid	(purple, brown, gray)	8	0.601	178
3109-42-01	3109-60-01	10/4	Solid	(brown, orange, yellow, gray)	8	0.651	242
3109-42-07	3109-60-07	10/4	Solid	(purple, brown, yellow, gray)	8	0.651	242
120/208V Stranded							
3158-42-00	3158-60-00	12/2	Stranded	(black, white)	10	0.482	94
3158-42-04	3158-60-04	12/2	Stranded	(red, white)	10	0.482	94
3158-42-05	3158-60-05	12/2	Stranded	(blue, white)	10	0.482	94
3159-42-00	3159-60-00	12/3	Stranded	(black, red, white)	10	0.523	126
3160-42-00	3160-60-00	12/4	Stranded	(black, red, blue, white)	10	0.585	158
3161-42-00	3161-60-00	10/2	Stranded	(black, white)	8	0.552	151
3162-42-00	3162-60-00	10/3	Stranded	(black, red, white)	8	0.625	202
3163-42-00	3163-60-00	10/4	Stranded	(black, red, blue, white)	8	0.680	261
277/480V Stranded							
3158-42-01	3158-60-01	12/2	Stranded	(brown, gray)	10	0.482	94
3158-42-02	3158-60-02	12/2	Stranded	(orange, gray)	10	0.482	94
3158-42-03	3158-60-03	12/2	Stranded	(yellow, gray)	10	0.482	94
3159-42-01	3159-60-01	12/3	Stranded	(brown, orange, gray)	10	0.539	126
3159-42-02	3159-60-02	12/3	Stranded	(orange, yellow, gray)	10	0.539	126
3159-42-03	3159-60-03	12/3	Stranded	(yellow, brown gray)	10	0.539	126
3160-42-01	3160-60-01	12/4	Stranded	(brown, orange, yellow, gray)	10	0.585	158
3161-42-01	3161-60-01	10/2	Stranded	(brown, gray)	8	0.552	151
3162-42-01	3162-60-01	10/3	Stranded	(brown, orange, gray)	8	0.625	202
3163-42-01	3163-60-01	10/4	Stranded	(brown, orange, yellow, gray)	8	0.680	260

NOTE: All dimensions and weights are subject to normal manufacturing tolerances.

SEE CONNECTOR MCI-A CROSS-REFERENCE GUIDE FOR ASSISTANCE IN SELECTING AN MCI-A LISTED CONNECTOR.

MC-Stat® & MC-Stat® Lite Cable

MCI-A Cables (Steel or Aluminum) (120/208V & 480Y/277V)

Technical Specifications Healthcare Cables



Specification Description

Specification	MC-Stat® & MC-Stat® Lite
Armor	Galvanized Interlocking Steel or Aluminum Strip (light green striped)
Conductors	Solid/Stranded Copper
Conductor Insulation	Type THHN with protective polypropylene covering on each insulated conductor (no messy assembly tape)
Max. Temp. Rating	90°C (dry)
Grounding	Two grounding means - (1) armor PLUS full-sized aluminum ground conductor, (2) Full-sized green insulated copper grounding conductor NEC® 250.118(10)(b)
Neutral Conductor	White 120/208V - Grey 277/480V
Max. Voltage Rating	600V

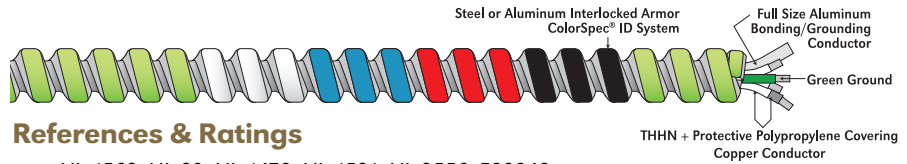

References & Ratings

- UL 1569, UL 83, UL 1479, UL 1581, UL 2556, E80042
- Federal spec A-A-59544 (formerly J-C-30B)
- NEC® 330, 300.22(C), 230.43, 250.118, 392, 396, 503, 530, 517, 518, 520, 645
- Permitted for use in Cable Trays
- Meets all OSHA and HUD requirements
- May be surface mounted, fished and/or embedded in plaster
- UL Classified 1, 2, and 3 hour through (Fire) penetration product, R-14141
- NEC® 300.22(C) Environmental Air Handling Spaces
- Cable Tray Rated, install per NEC®
- Patent Pending
- Made in USA of US and/or imported materials



Product Codes, Trade Sizes, Conductors, Packaging & Weights

Product Code No. 250' Coil	Product Code No. 1000' Reel	Trade Size AWG	Copper Cond. Type	Conductor Colors	Grounding Conductor AWG Color	Bare Alum. Bonding/Bond Cond. AWG	Cable Nominal O.D. (in)	Approx. Weight 1000 Ft. (lbs.)
MC-Stat® Cable								
120/208V Solid								
7504-42-00	7504-60-00	12/2	solid	black, white	12/green	10	0.523	160
7504-42-04	7504-60-04	12/2	solid	red, white	12/green	10	0.523	160
7504-42-05	7504-60-05	12/2	solid	blue, white	12/green	10	0.523	160
7505-42-00	7505-60-00	12/3	solid	black, red, white	12/green	10	0.565	208
7505-42-04	7505-60-04	12/3	solid	red, blue, white	12/green	10	0.565	208
7505-42-05	7505-60-05	12/3	solid	black, blue, white	12/green	10	0.565	208
7506-42-00	7506-60-00	12/4	solid	black, red, blue, white	12/green	10	0.618	263
7507-42-00	7507-60-00	10/2	solid	black, white	10/green	8	0.601	240
7508-42-00	7508-60-00	10/3	solid	black, red, white	10/green	8	0.651	310
7509-42-00	7509-60-00	10/4	solid	black, red, blue, white	10/green	8	0.786	407
277/480V Solid								
7504-42-01	7504-60-01	12/2	solid	brown, gray	12/green	10	0.523	160
7504-42-02	7504-60-02	12/2	solid	orange, gray	12/green	10	0.523	160
7504-42-03	7504-60-03	12/2	solid	yellow, gray	12/green	10	0.523	160
7504-42-07	7504-60-07	12/2	solid	purple, gray	12/green	10	0.523	160
7505-42-01	7505-60-01	12/3	solid	brown, orange, gray	12/green	10	0.565	208
7505-42-02	7505-60-02	12/3	solid	orange, yellow, gray	12/green	10	0.565	208
7505-42-03	7505-60-03	12/3	solid	brown, yellow, gray	12/green	10	0.565	208
7505-42-07	7505-60-07	12/3	solid	purple, brown, gray	12/green	10	0.565	208
7505-42-27	7505-60-27	12/3	solid	purple, yellow, gray	12/green	10	0.565	208
7506-42-01	7506-60-01	12/4	solid	brown, orange, yellow, gray	12/green	10	0.618	263
7506-42-07	7506-60-07	12/4	solid	purple, brown, yellow, gray	12/green	10	0.618	263
MC-Stat® Lite Cable								
120/208V Solid								
5804-42-00	5804-60-00	12/2	solid	black, white	12/green	10	0.523	122
5804-42-04	5804-60-04	12/2	solid	red, white	12/green	10	0.523	122
5804-42-05	5804-60-05	12/2	solid	blue, white	12/green	10	0.523	122
5805-42-00	5805-60-00	12/3	solid	black, red, white	12/green	10	0.565	152
5805-42-04	5805-60-04	12/3	solid	red, blue, white	12/green	10	0.565	152
5805-42-05	5805-60-05	12/3	solid	black, blue, white	12/green	10	0.565	152
5806-42-00	5806-60-00	12/4	solid	black, red, blue, white	12/green	10	0.618	200
5807-42-00	5807-60-00	10/2	solid	black, white	10/green	8	0.601	178
5808-42-00	5808-60-00	10/3	solid	black, red, white	10/green	8	0.651	242
5809-42-00	5809-60-00	10/4	solid	black, red, blue, white	10/green	8	0.786	301
277/480V Solid								
5804-42-01	5804-60-01	12/2	solid	brown, gray	12/green	10	0.523	122
5804-42-02	5804-60-02	12/2	solid	orange, gray	12/green	10	0.523	122
5804-42-03	5804-60-03	12/2	solid	yellow, gray	12/green	10	0.523	122
5804-42-07	5804-60-07	12/2	solid	purple, gray	12/green	10	0.523	122
5805-42-01	5805-60-01	12/3	solid	brown, orange, gray	12/green	10	0.565	152
5806-42-01	5806-60-01	12/4	solid	brown, orange, yellow, gray	12/green	10	0.618	200
120/208V Stranded								
5858-42-00	5858-60-00	12/2	stranded	black, white	12/green	10	0.539	127
5858-42-04	5858-60-04	12/2	stranded	red, white	12/green	10	0.539	127
5858-42-05	5858-60-05	12/2	stranded	blue, white	12/green	10	0.539	127
5859-42-00	5859-60-00	12/3	stranded	black, red, white	12/green	10	0.565	158
5859-42-04	5859-60-04	12/3	stranded	red, blue, white	12/green	10	0.565	158
5859-42-05	5859-60-05	12/3	stranded	black, blue, white	12/green	10	0.565	158
5860-42-00	5860-60-00	12/4	stranded	black, red, blue, white	12/green	10	0.645	210
277/480V Stranded								
5858-42-01	5858-60-01	12/2	stranded	brown, gray	12/green	10	0.539	127
5859-42-01	5859-60-01	12/3	stranded	brown, orange, gray	12/green	10	0.565	158
5860-42-01	5860-60-01	12/4	stranded	brown, orange, yellow, gray	12/green	10	0.645	211

NOTE: All dimensions and weights are subject to normal manufacturing tolerances. **WARNING: DO NOT RE-IDENTIFY CONDUCTOR COLORS.**

SEE CONNECTOR MCI-A CROSS-REFERENCE GUIDE FOR ASSISTANCE IN SELECTING AN MCI-A LISTED CONNECTOR.

MC-Stat® Plus & MC-Stat® Plus Lite Cable

MCI-A Cables (Steel or Aluminum) (120/208V) Technical Specifications

Neutral Per Phase Healthcare Cables



Specification Description

Specification	MC-Stat® Plus & MC-Stat® Lite Plus
Armor	Galvanized Interlocking Steel or Aluminum Strip (light green striped)
Conductors	Solid/Stranded Copper
Conductor Insulation	Type THHN with protective polypropylene covering on each insulated conductor (no messy assembly tape)
Maximum Temperature Rating	90°C (dry)
Grounding	Two grounding means - (1) armor PLUS full-sized aluminum ground conductor, (2) Full-sized green insulated copper grounding conductor NEC® 250.118(10)(b)
Neutral Conductor	White 120/208V - Grey 277/480V
Maximum Voltage Rating	600V

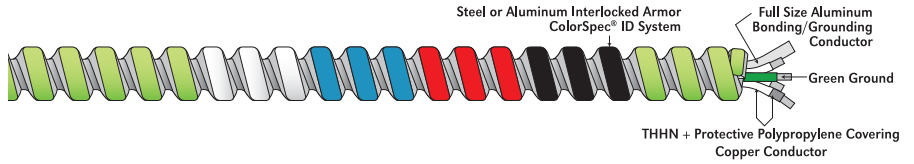

References & Ratings

- UL 1569, UL 83, UL 1479, UL 1581, UL 2556, E80042
- Federal spec A-A-59544 (formerly J-C-30B)
- NEC® 210.4(B), 330, 300.22(C), 230.43, 250.118, 392, 396, 503, 530, 517, 518, 530, 645
- Meets all OSHA and HUD requirements
- May be surface mounted, fished and/or embedded in plaster
- UL Classified 1, 2, and 3 hour through (Fire) penetration product, R-14141
- NEC® 300.22(C) Environmental Air Handling Spaces
- Cable Tray Rated, install per NEC®
- Patent Pending
- Made in USA of US and/or imported materials



Product Codes, Trade Sizes, Conductors, Packaging & Weights

Product Code No. 1000' Reel	Phase Conductor AWG	Neutral Conductor AWG	Insulated Grounding Wire AWG	Bare Alum. Bonding/Bond Cond. AWG	Approx. Weight 1000 Ft. (lbs.)	Armor Nom. O.D. (inches)
MC-Stat® Plus Steel Cable						
120/208V Solid						
7004-60-00	12-2 (a)	12-2 (f)	12-1 (solid green)	10-1	262.7	0.618
7005-60-00	12-3 (b)	12-3 (g)	12-1 (solid green)	10-1	326.8	0.663
7007-60-00	10-2 (a)	10-2 (f)	10-1 (solid green)	8-1	406.9	0.786
7008-60-00	10-3 (b)	10-3 (g)	10-1 (solid green)	8-1	540.1	0.893
MC-Stat® Lite Plus Aluminum Cable						
120/208V Solid						
7304-60-00	12-2 (a)	12-2 (f)	12-1 (solid green)	10-1	200.1	0.618
7305-60-00	12-3 (b)	12-3 (g)	12-1 (solid green)	10-1	257.9	0.663
7307-60-00	10-2 (a)	10-2 (f)	10-1 (solid green)	8-1	301.9	0.786
7308-60-00	10-3 (b)	10-3 (g)	10-1 (solid green)	8-1	391.5	0.893

NOTE: All dimensions and weights are subject to normal manufacturing tolerances.

Conductor Color Key;

- (a) black, red
- (b) black, red, blue
- (f) white with black text, white with red text
- (g) white with black text, white with red text, white with blue text

NOTE: All dimensions and weights are subject to normal manufacturing tolerances. Other conductor colors available by special order. **WARNING: DO NOT RE-IDENTIFY CONDUCTOR COLORS.**

SEE CONNECTOR MCI-A CROSS-REFERENCE GUIDE FOR ASSISTANCE IN SELECTING AN MCI-A LISTED CONNECTOR.

Installation Instructions MC-Quik® Type MC Cable

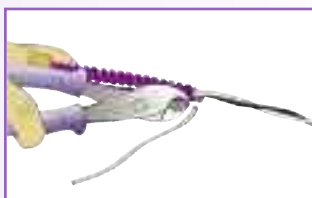
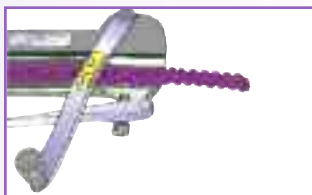

1. Cut the cable to length needed and remove armor approximately 6-inches from end using a rotary cutting tool designed for use with Interlocked Metal-Clad Cable and remove armor.
2. Separate the bare aluminum grounding/bonding conductor from the cable assembly by folding the bare aluminum grounding/bonding conductor back approximately 120°.
3. Cut the aluminum bare grounding/bonding conductor flush with the end of the armor using a suitable tool.
4. Use a fitting identified and listed* for use with a Metal-Clad Interlocking Armor Ground Cable (Type MCI-A), install the fitting per the manufacturer's instructions.
5. Bond the cable, fitting, box and wiring devices, as applicable, to provide an effective ground-fault current path.

NOTES:

1. The combination of the metal armor and the bare aluminum grounding/bonding conductor is the effective ground-fault path in accordance with NEC® 250.118(10)(b).
2. OPTIONAL INSTALLATION METHOD: Although not required, the bare aluminum grounding/bonding conductor may be terminated inside the box or enclosure provided the splices, connectors or terminations are suitable for the material of the conductor(s) to be used per NEC® 110.14.
3. *The fitting must be listed and marked for use with "Metal-Clad Interlocking Ground Cable Type" or "MCI-A" where the armor is a component of the equipment grounding path.
4. Cable has one grounding means - armor/bond-ground wire combination.

Installation Instructions MC-Stat® Type MC Cable



1. Cut the cable to length needed and remove armor approximately 6-inches from end using a rotary cutting tool designed for use with Interlocked Metal-Clad Cable and remove armor.
2. Separate the bare aluminum grounding/bonding conductor from the cable assembly by folding the bare aluminum grounding/bonding conductor back approximately 120°.
3. Cut the bare aluminum grounding/bonding conductor flush with the end of the armor using a suitable tool.
4. Use a fitting identified and listed* for use with a Metal-Clad Interlocking Armor Ground Cable (Type MCI-A), install the fitting per the manufacturer's instructions.
5. Bond the cable, fitting, box and wiring device, as applicable, to provide an effective ground-fault current path to comply with NEC® 517.13(A). Terminate the green equipment grounding conductor to the device, the grounding screw or other grounding connection to comply with NEC® 517.13(B).

NOTES:

1. The combination of the metal armor and the bare aluminum grounding/bonding conductor is the effective ground-fault path in accordance with NEC® 250.118(10)(b).
2. OPTIONAL INSTALLATION METHOD: Although not required, the bare aluminum grounding/bonding conductor may be terminated inside the box or enclosure provided the splices, connectors or terminations are suitable for the material of the conductor(s) to be used per NEC® 110.14.
3. *The fitting must be listed and marked for use with "Metal-Clad Interlocking Ground Cable Type" or "MCI-A" where the armor is a component of the equipment grounding path.
4. The green insulated equipment grounding conductor is an effective ground-fault current path in accordance with NEC® 250.118(1).
5. Cable has two (2) grounding means:
 - (1) Armor/Bond-ground wire combination
 - (2) Green insulated grounding conductor in accordance with NEC® 250.118(10) (b) and 250.118(1).

MC TUFF® Lightweight Steel Cable – Traditional Type MC (120/208V) Technical Specifications



Specification Description

Specification	MC TUFF® ColorSpec® ID System
Armor	Galvanized Interlocking Steel Strip (blue striped)
Conductors	Solid/Stranded Copper
Conductor Insulation	THHN/THWN (XHHW available by special order subject to lead time and minimum quantities)
Assembly Covering	Polypropylene Tape
Maximum Temperature Rating	90°C (dry)
Grounding	One grounding means – Insulated Green Grounding Conductor
Neutral Conductor	White
Maximum Voltage Rating	600V

References & Ratings

- UL 83, 1479, 1569, 1581, 2556, File Reference E80042
- NEC® 230.43, 300.22(C), 392, 396, 330, 501, 502, 503, 530, 504, 505, 518, 520, 530, 645
- Federal Specification A-A-59544 (formerly J-C-30B)
- Meets all applicable OSHA and HUD Requirements
- May be surface mounted, fished and/or embedded in plaster
- Cable Tray Rated, install per NEC®
- UL Classified 1, 2, and 3 hour through (Fire) penetration product, R-14141
- Environmental Air-Handling Space Installation per NEC® 300.22(C)
- Made in USA of US and/or imported materials

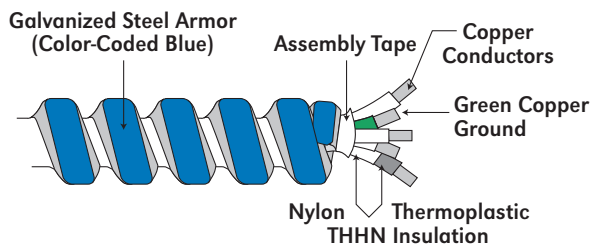

Product Codes, Trade Sizes, Conductors, Packaging & Weights

Product Code Coil	Product Code Reel	Trade Size	Grounding Conductor AWG	Length (feet)		Approx. Weight/1000 Feet (lbs.)	Armor Minimum O.D. (inches)
				Coil	Reel		
Solid Wire							
1701B42T00	1701B60T00	14-2 Solid (black, white)	14 (solid green)	250'	1000'	117	0.470
1702B42T00	1702B60T00	14-3 Solid (black, red, white)	14 (solid green)	250'	1000'	140	0.480
1703B42T00	1703B60T00	14-4 Solid (black, red, blue, white)	14 (solid green)	250'	1000'	164	0.510
1704B42T00	1704B60T00	12-2 Solid (black, white)	12 (solid green)	250'	1000'	147	0.495
1705B42T00	1705B60T00	12-3 Solid (black, red, white)	12 (solid green)	250'	1000'	186	0.530
1706B42T00	1706B60T00	12-4 Solid (black, red, blue, white)	12 (solid green)	250'	1000'	223	0.565
1707B42T00	1707B60T00	10-2 Solid (black, white)	10 (solid green)	250'	1000'	222	0.560
1708B42T00	1708B60T00	10-3 Solid (black, red, white)	10 (solid green)	250'	1000'	268	0.600
1709B42T00	1709B60T00	10-4 Solid (black, red, blue, white)	10 (solid green)	250'	1000'	313	0.645
Stranded Wire							
1758B42T00	1758B60T00	12-2 Stranded (black, white)	12 (stranded green)	250'	1000'	152	0.495
1759B42T00	1759B60T00	12-3 Stranded (black, red, white)	12 (stranded green)	250'	1000'	191	0.530
1760B42T00	1760B60T00	12-4 Stranded (black, red, blue, white)	12 (stranded green)	250'	1000'	225	0.565
1761B42T00	1761B60T00	10-2 Stranded (black, white)	10 (stranded green)	250'	1000'	227	0.560
1762B42T00	1762B60T00	10-3 Stranded (black, red, white)	10 (stranded green)	250'	1000'	269	0.600
1763B42T00	1763B60T00	10-4 Stranded (black, red, blue, white)	10 (stranded green)	250'	1000'	319	0.645
Specialty Colors							
1704B42T04	1704B60T04	12-2 Solid (red, white)	12 (solid green)	250'	1000'	147	0.495
1704B42T05	1704B60T05	12-2 Solid (blue, white)	12 (solid green)	250'	1000'	147	0.495
1705B42T04	1705B60T04	12-3 Solid (red, blue, white)	12 (solid green)	250'	1000'	147	0.495
1705B42T05	1705B60T05	12-3 Solid (black, blue, white)	12 (solid green)	250'	1000'	147	0.495
1707B42T04	1707B60T04	10-2 Solid (red, white)	10 (solid green)	250'	1000'	222	0.560
1707B42T05	1707B60T05	10-2 Solid (blue, white)	10 (solid green)	250'	1000'	222	0.560
1708B42T04	1708B60T04	10-3 Solid (red, blue, white)	10 (solid green)	250'	1000'	268	0.600
1708B42T05	1708B60T05	10-3 Solid (black, blue, white)	10 (solid green)	250'	1000'	268	0.600

NOTE: All dimensions and weights are subject to normal manufacturing tolerances.

SET SCREW CONNECTORS MAY BE USED WITH STEEL CABLES, SEE CONNECTOR CROSS-REFERENCE GUIDE FOR DETAILS.

MC TUFF® Lightweight Steel Cable – Traditional Type MC (480Y/277V) Technical Specifications



Specification Description

Specification	MC TUFF® ColorSpec® ID System
Armor	Galvanized Interlocking Steel Strip (blue striped)
Conductors	Solid or Stranded Copper (see below)
Conductor Insulation	THHN/THWN (XHHW available by special order subject to lead time and minimum quantities)
Assembly Covering	Polypropylene tape
Maximum Temperature Rating	90°C (dry)
Grounding	One grounding means – Insulated Green Grounding Conductor
Neutral Conductor	Grey
Maximum Voltage Rating	600V

References & Ratings

- UL 83, 1479, 1569, 1581, 2556, File Reference E80042
- NEC® 230.43, 300.22(C), 392, 396, 330, 501, 502, 503, 530, 504, 505, 518, 520, 530, 645
- Cable Tray Rated, install per NEC
- Federal Specification A-A-59544 (formerly J-C-30B)
- Meets all applicable OSHA and HUD requirements
- May be surfaced mounted and embedded in plaster
- Environmental Air-Handling Space Installation per NEC® 300.22(C)
- UL Classified 1, 2, and 3 hour through (Fire) penetration product, R-14141
- Made in USA of US and/or imported materials

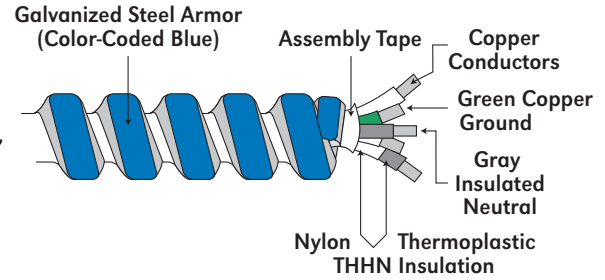

Product Codes, Trade Sizes, Conductors, Packaging & Weights

Product Code Coil	Reel	Trade Size	Grounding Conductors AWG	Length (feet)		Approx. Weight/1000 Feet (lbs.)	Armor Minimum O.D. (inches)
				Coil	Reel		
Solid Wire							
1704B42T01	1704B60T01	12-2 Solid (brown, gray)	12 (solid green)	250'	1000'	147	0.495
1704B42T02	1704B60T02	12-2 Solid (orange, gray)	12 (solid green)	250'	1000'	147	0.495
1704B42T03	1704B60T03	12-2 Solid (yellow, gray)	12 (solid green)	250'	1000'	147	0.495
1704B42T07	1704B60T07	12-2 Solid (purple, gray)	12 (solid green)	250'	1000'	147	0.495
1705B42T01	1705B60T01	12-3 Solid (brown, orange, gray)	12 (solid green)	250'	1000'	186	0.530
1705B42T02	1705B60T02	12-3 Solid (orange, yellow, gray)	12 (solid green)	250'	1000'	186	0.530
1705B42T03	1705B60T03	12-3 Solid (brown, yellow, gray)	12 (solid green)	250'	1000'	186	0.530
1705B42T07	1705B60T07	12-3 Solid (brown, purple, gray)	12 (solid green)	250'	1000'	186	0.530
1705B42T27	1705B60T27	12-3 Solid (yellow, purple, gray)	12 (solid green)	250'	1000'	186	0.530
1706B42T01	1706B60T01	12-4 Solid (brown, orange, yellow, gray)	12 (solid green)	250'	1000'	223	0.565
1706B42T07	1706B60T07	12-4 Solid (brown, yellow, purple, gray)	12 (solid green)	250'	1000'	223	0.565
1707B42T01	1707B60T01	10-2 Solid (brown, gray)	10 (solid green)	250'	1000'	222	0.560
1707B42T02	1707B60T02	10-2 Solid (orange, gray)	10 (solid green)	250'	1000'	222	0.560
1707B42T03	1707B60T03	10-2 Solid (yellow, gray)	10 (solid green)	250'	1000'	222	0.560
1707B42T07	1707B60T07	10-2 Solid (purple, gray)	10 (solid green)	250'	1000'	222	0.560
1708B42T01	1708B60T01	10-3 Solid (brown, orange, gray)	10 (solid green)	250'	1000'	268	0.600
1708B42T02	1708B60T02	10-3 Solid (orange, yellow, gray)	10 (solid green)	250'	1000'	268	0.600
1708B42T03	1708B60T03	10-3 Solid (brown, yellow, gray)	10 (solid green)	250'	1000'	268	0.600
1709B42T01	1709B60T01	10-4 Solid (brown, orange, yellow, gray)	10 (solid green)	250'	1000'	313	0.645
1709B42T07	1709B60T07	10-4 Solid (brown, yellow, purple, gray)	10 (solid green)	250'	1000'	313	0.645
Stranded Wire							
1758B42T01	1758B60T01	12-2 Stranded (brown, gray)	12 (stranded green)	250'	1000'	152	0.495
1758B42T02	1758B60T02	12-2 Stranded (orange, gray)	12 (stranded green)	250'	1000'	152	0.495
1758B42T03	1758B60T03	12-2 Stranded (yellow, gray)	12 (stranded green)	250'	1000'	152	0.495
1759B42T01	1759B60T01	12-3 Stranded (brown, orange, gray)	12 (stranded green)	250'	1000'	191	0.530
1760B42T01	1760B60T01	12-4 Stranded (brown, orange, yellow, gray)	12 (stranded green)	250'	1000'	191	0.530
1761B42T01	1761B60T01	10-2 Stranded (brown, gray)	10 (stranded green)	250'	1000'	227	0.560
1762B42T01	1762B60T01	10-3 Stranded (brown, orange, gray)	10 (stranded green)	250'	1000'	269	0.600
1763B42T01	1763B60T01	10-4 Stranded (brown, orange, yellow, gray)	10 (stranded green)	250'	1000'	319	0.645

NOTE: All dimensions and weights are subject to normal manufacturing tolerances. Other conductor colors available by special order.

SET SCREW CONNECTORS MAY BE USED WITH STEEL CABLES, SEE CONNECTOR CROSS-REFERENCE GUIDE FOR DETAILS.

Type MC Steel Metal Clad Cable – Traditional Type MC (8 AWG-2 – 4/0 AWG-4) Technical Specifications

Specification Description

Specification	MC Steel
Armor	Galvanized Interlocking Steel Strip
Conductors	Stranded Copper
Conductor Insulation	THHN/THWN
Assembly Covering	Polypropylene Tape
Maximum Temperature Rating	90°C (dry)
Grounding	One grounding means – may be insulated or bare
Neutral Conductor	White
Maximum Voltage Rating	600V

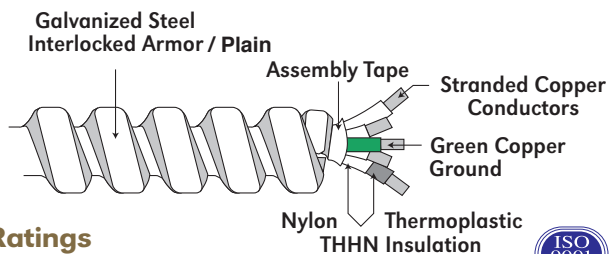

References & Ratings

- UL 83, 1479, 1569, 1581, 2556, File Reference E80042
- NEC® 230.43, 300.22(C), 392, 396, 330, 501, 502, 503, 530, 504, 505, 518, 520, 530, 645
- Federal Specification A-A-59544 (formerly J-C-30B)
- Meets all applicable OSHA and HUD Requirements
- Cable Tray Rated, install per NEC®
- UL Classified 1, 2, and 3 hour through (Fire) penetration product, R-14141
- Environmental Air-Handling Space Installation per NEC® 300.22(C)
- Made in USA of US and/or imported materials

Product Codes, Trade Sizes, Conductors, Packaging & Weights

Product Code Coil	Product Code Reel	Trade Size	Grounding Conductor AWG	Length (feet)		Approx. Weight/ 1000 Feet (lbs.)	Armor Minimum O.D. (inches)
				Coil	Reel		
Stock Items							
1715-40-00	1715-45-00	8-2 Stranded	10 Stranded	200'	500'	329	0.651
1716-40-00	1716-45-00	8-3 Stranded	10 Stranded	200'	500'	432	0.704
1717-32-00	1717-45-00	8-4 Stranded	10 Stranded	125'	500'	511	0.852
1719-32-00	1719-45-00	6-2 Stranded	8 Stranded	125'	500'	462	0.795
1720-32-00	1720-45-00	6-3 Stranded	8 Stranded	125'	500'	594	0.855
1721-30-00	1721-45-00	6-4 Stranded	8 Stranded	100'	500'	860	0.945
1724-30-00	1724-45-00	4-3 Stranded	8 Stranded	100'	500'	985	1.035
1725-30-00	1725-45-00	4-4 Stranded	8 Stranded	100'	500'	1195	1.135
1728-30-00	1728-45-00	3-3 Stranded	6 Stranded	100'	500'	1070	1.025
1729-30-00	1729-45-00	3-4 Stranded	6 Stranded	100'	500'	1260	1.120
1726-30-00	1726-45-00	2-3 Stranded	6 Stranded	100'	500'	1340	1.180
1727-30-00	1727-45-00	2-4 Stranded	6 Stranded	100'	500'	1640	1.295
1737-30-00	1737-45-00	1-3 Stranded	6 Stranded	100'	500'	1530	1.185
–	1738-99-00	1-4 Stranded	6 Stranded	††	††	1930	1.350
–	1770-99-00	1/0-3 Stranded	bare #6	††	††	1780	1.255
–	1771-99-00	1/0-4 Stranded	bare #6	††	††	2220	1.390
–	1772-99-00	2/0-3 Stranded	bare #6	††	††	2095	1.350
–	1773-99-00	2/0-4 Stranded	bare #6	††	††	2650	1.520
–	1774-99-00	3/0-3 Stranded	bare #4	††	††	2580	1.520
–	1775-99-00	3/0-4 Stranded	bare #4	††	††	3245	1.690
–	1776-99-00	4/0-3 Stranded	bare #4	††	††	3040	1.580
–	1777-99-00	4/0-4 Stranded	bare #4	††	††	3855	1.770

NOTE: All dimensions and weights are subject to normal manufacturing tolerances.

†† Cut to order.

XHHW INSULATION BY SPECIAL ORDER. CALL FOR DETAILS.

MC Lite[®] Metal Clad Aluminum Armored Cable – Traditional Type MC (120/208V & 480Y/277V, 10AWG & Larger) Technical Specifications

Specification Description

Specification	MC Lite [®]
Armor	Interlocking Aluminum Strip
Conductors	Solid/Stranded Copper
Conductor Insulation	THHN/THWN
Assembly Covering	Polypropylene Tape
Maximum Temperature Rating	90°C (dry)
Grounding	One grounding means - Insulated Green Grounding Conductor
Neutral Conductor	White for 120/208V circuits Grey for 480Y/277V circuits
Maximum Voltage Rating	600V

References & Ratings

- UL 83, 1479, 1569, 1581, 2556, File Reference E80042
- NEC[®] 230.43, 300.22(C), 392, 396, 330, 501, 502, 503, 530, 504, 505, 518, 520, 530, 645
- Federal Specification A-A-59544 (formerly J-C-30B)
- Meets all applicable OSHA and HUD Requirements
- May be surface mounted, fished and/or embedded in plaster
- Cable Tray Rated, install per NEC[®]
- UL Classified 1, 2, and 3 hour through (Fire) penetration product, R-14141
- Environmental Air-Handling Space Installation per NEC[®] 300.22(C)
- RoHS Compliant
- Made in USA of US and/or imported materials

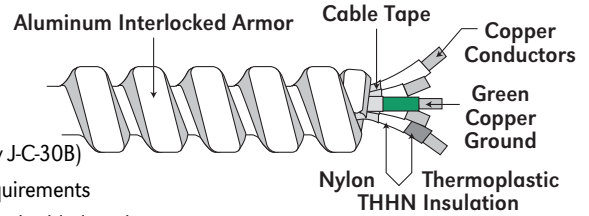

Product Codes, Trade Sizes, Conductors, Packaging & Weights

Product Code Coil	Reel	Trade Size	Grounding Conductor AWG	Length (feet)		Approx. Weight/1000 Feet (lbs.)	Armor Minimum O.D. (inches)
				Coil	Reel		
120/208V Solid Conductor Colors							
2107-42-00	2107-60-00	10-2 Solid (black, white)	10 (solid green)	250'	1000'	160	0.560
2108-42-00	2108-60-00	10-3 Solid (black, red, white)	10 (solid green)	250'	1000'	215	0.600
2109-42-00	2109-60-00	10-4 Solid (black, red, blue, white)	10 (solid green)	250'	1000'	260	0.645
2107-42-04	2107-60-04	10-2 Solid (red, white)	10 (solid green)	250'	1000'	160	0.560
2107-42-05	2107-60-05	10-2 Solid (blue, white)	10 (solid green)	250'	1000'	160	0.560
2108-42-04	2108-60-04	10-3 Solid (red, blue, white)	10 (solid green)	250'	1000'	215	0.600
2108-42-05	2108-60-05	10-3 Solid (black, blue, white)	10 (solid green)	250'	1000'	215	0.600
120/208V Stranded Conductor Colors							
2161-42-00	2161-60-00	10-2 Stranded (black, white)	10 (stranded green)	250'	1000'	160	0.560
2162-42-00	2162-60-00	10-3 Stranded (black, red, white)	10 (stranded green)	250'	1000'	215	0.600
2163-42-00	2163-60-00	10-4 Stranded (black, red, blue, white)	10 (stranded green)	250'	1000'	260	0.645
2115-40-00	2115-45-00	8-2 Stranded (black, white)	10 (solid green)	200'	500'	265	0.635
2116-40-00	2116-45-00	8-3 Stranded (black, red, white)	10 (solid green)	200'	500'	335	0.685
2117-32-00	2117-45-00	8-4 Stranded (black, red, blue, white)	10 (solid green)	125'	500'	415	0.835
2119-32-00	2119-45-00	6-2 Stranded (black, white)	8 (stranded green)	125'	500'	370	0.795
2120-32-00	2120-45-00	6-3 Stranded (black, red, white)	8 (stranded green)	125'	500'	480	0.855
2121-30-00	2121-45-00	6-4 Stranded (black, red, blue, white)	8 (stranded green)	100'	500'	595	0.945
2124-30-00	2124-45-00	4-3 Stranded (black, red, white)	8 (stranded green)	100'	500'	690	1.035
2125-30-00	2125-45-00	4-4 Stranded (black, red, blue, white)	8 (stranded green)	100'	500'	870	1.135
2128-30-00	2128-45-00	3-3 Stranded (black, red, white)	6 (stranded green)	100'	500'	815	1.025
2129-30-00	2129-45-00	3-4 Stranded (black, red, blue, white)	6 (stranded green)	100'	500'	1025	1.120
2126-30-00	2126-45-00	2-3 Stranded (black, red, white)	6 (stranded green)	100'	500'	1000	1.180
2127-30-00	2127-45-00	2-4 Stranded (black, red, blue, white)	6 (stranded green)	100'	500'	1260	1.295
2137-30-00	2137-45-00	1-3 Stranded (black, red, white)	6 (stranded green)	100'	500'	1195	1.185
2161-42-01	2161-60-01	10-2 Stranded (brown, gray)	10 (stranded green)	250'	1000'	160	0.560
2163-42-01	2163-60-01	10-4 Stranded (brown, orange, yellow, gray)	10 (stranded green)	250'	1000'	260	0.645
480Y/277V Solid Conductor Colors							
2107-42-01	2107-60-01	10-2 Solid (brown, gray)	10 (solid green)	250'	1000'	160	0.560
2108-42-01	2108-60-01	10-3 Solid (brown, orange, gray)	10 (solid green)	250'	1000'	215	0.600
2109-42-01	2109-60-01	10-4 Solid (brown, orange, yellow, gray)	10 (solid green)	250'	1000'	260	0.645
2107-42-02	2107-60-02	10-2 Solid (orange, gray)	10 (solid green)	250'	1000'	160	0.560
2107-42-03	2107-60-03	10-2 Solid (yellow, gray)	10 (solid green)	250'	1000'	160	0.560
2108-42-02	2108-60-02	10-3 Solid (orange, yellow, gray)	10 (solid green)	250'	1000'	215	0.600
2108-42-03	2108-60-03	10-3 Solid (brown, yellow, gray)	10 (solid green)	250'	1000'	215	0.600
480Y/277V Stranded Conductor Colors							
2115-40-01	2115-45-01	8-2 Stranded (brown, gray)	10 (solid green)	200'	500'	329	0.635
2116-40-01	2116-45-01	8-3 Stranded (brown, orange, gray)	10 (solid green)	200'	500'	432	0.685
2117-32-01	2117-45-01	8-4 Stranded (brown, orange, yellow, gray)	10 (solid green)	125'	500'	511	0.835
2120-32-01	2120-45-01	6-3 Stranded (brown, orange, gray)	8 (stranded green)	125'	500'	594	0.855
2121-30-01	2121-45-01	6-4 Stranded (brown, orange, yellow, gray)	8 (stranded green)	100'	500'	595	0.945

NOTE: All dimensions and weights are subject to normal manufacturing tolerances. Other conductor colors available by special order.

* Stranded conductors available by special order.

MC Lite[®] Aluminum Armored Cable – Traditional Type MC (120/208V) Technical Specifications

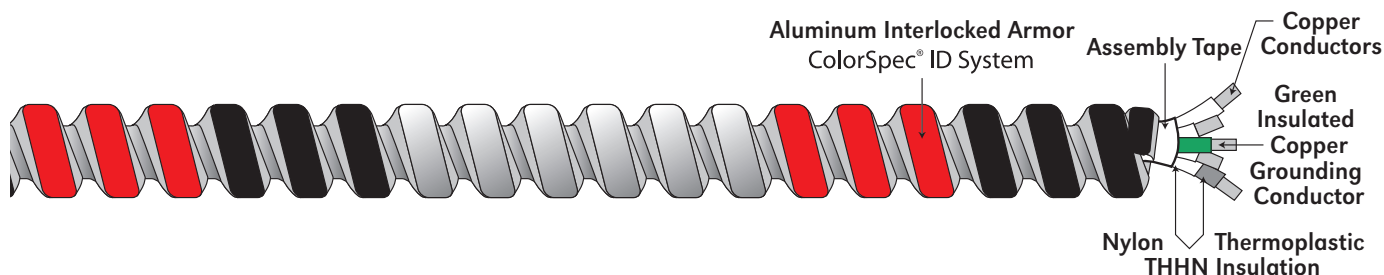

Specification Description

Specification	MC Lite [®] ColorSpec [®] ID System
Armor	Interlocking Aluminum Strip
Conductors	Solid/Stranded Copper
Conductor Insulation	THHN/THWN
Assembly Covering	Polypropylene Tape
Maximum Temperature Rating	90°C (dry)
Grounding	One grounding means – Insulated Green Grounding Conductor
Neutral Conductor	White 120/208V
Maximum Voltage Rating	600V

References & Ratings

- UL 83, 1479, 1569, 1581, 2556, File Reference E80042
- NEC[®] 230.43, 300.22(C), 392, 396, 330, 501, 502, 503, 530, 504, 505, 518, 520, 530, 645
- Federal Specification A-A-59544 (formerly J-C-30B)
- Meets all applicable OSHA and HUD Requirements
- May be surface mounted, fished and/or embedded in plaster
- Cable tray rated, install per NEC[®]
- UL Classified 1, 2, and 3 hour through (Fire) penetration product, R-14141
- Environmental Air-Handling Space Installation per NEC[®] 300.22(C)
- Aluminum armored cables are RoHS Compliant
- Made in USA of US and/or imported materials



Product Codes, Trade Sizes, Conductors, Packaging & Weights

Product Code		Trade Size	Grounding Conductor AWG	Length (feet)		Approx. Weight/1000 Feet (lbs.)	Armor Minimum O.D. (inches)
Coil	Reel			Coil	Reel		
2101S42-00	2101S60-00	14-2 Solid (black, white)	14 (solid green)	250'	1000'	80	0.470
2102S42-00	2102S60-00	14-3 Solid (black, red, white)	14 (solid green)	250'	1000'	100	0.480
2103S42-00	2103S60-00	14-4 Solid (black, red, blue, white)	14 (solid green)	250'	1000'	120	0.510
2104S42-00	2104S60-00	12-2 Solid (black, white)	12 (solid green)	250'	1000'	110	0.495
2105S42-00	2105S60-00	12-3 Solid (black, red, white)	12 (solid green)	250'	1000'	135	0.530
2106S42-00	2106S60-00	12-4 Solid (black, red, blue, white)	12 (solid green)	250'	1000'	170	0.565
Stranded Conductors							
2158S42-00	2158S60-00	12-2 Stranded (black, white)	12 (stranded green)	250'	1000'	110	0.495
2159S42-00	2159S60-00	12-3 Stranded (black, red, white)	12 (stranded green)	250'	1000'	135	0.530
2160S42-00	2160S60-00	12-4 Stranded (black, red, blue, white)	12 (stranded green)	250'	1000'	170	0.565
Special 120/208V Colors							
2104S42-04	2104S60-04	12-2 Solid (red, white)	12 (solid green)	250'	1000'	110	0.495
2104S42-05	2104S60-05	12-2 Solid (blue, white)	12 (solid green)	250'	1000'	110	0.495
2105S42-04	2105S60-04	12-3 Solid (red, blue, white)	12 (solid green)	250'	1000'	135	0.530
2105S42-05	2105S60-05	12-3 Solid (black, blue, white)	12 (solid green)	250'	1000'	135	0.530

MC Lite[®] is also available in 10 AWG and larger, see page 19.

NOTE: All dimensions and weights are subject to normal manufacturing tolerances. Other conductor colors available by special order.

MC Lite[®] Aluminum Armored Cable – Traditional Type MC (480Y/277V) Technical Specifications

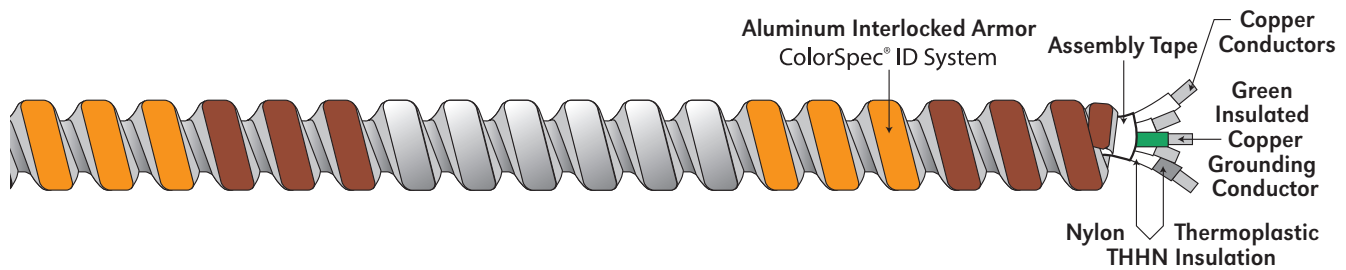

Specification Description

Specification	MC Lite [®] ColorSpec [®] ID System
Armor	Interlocking Aluminum Strip
Conductors	Solid/Stranded Copper
Conductor Insulation	THHN/THWN
Assembly Covering	Polypropylene Tape
Maximum Temperature Rating	90°C (dry)
Grounding	One grounding means – Insulated Green Grounding Conductor
Neutral Conductor	Grey for 480Y/277V circuits
Maximum Voltage Rating	600V

References & Ratings

- UL 83, 1479, 1569, 1581, 2556, File Reference E80042
- NEC[®] 230.43, 300.22(C), 392, 396, 330, 501, 502, 503, 530, 504, 505, 518, 520, 530, 645
- Federal Specification A-A-59544 (formerly J-C-30B)
- Meets all applicable OSHA and HUD Requirements
- May be surface mounted, fished and/or embedded in plaster
- Cable Tray Rated, install per NEC[®]
- UL Classified 1, 2, and 3 hour through (Fire) penetration product, R-14141
- Environmental Air-Handling Space Installation per NEC[®] 300.22(C)
- Aluminum armored cables are RoHS Compliant
- Made in USA of US and/or imported materials



Product Codes, Trade Sizes, Conductors, Packaging & Weights

Product Code		Trade Size	Grounding Conductor AWG	Length (feet)		Approx. Weight/1000 Feet (lbs.)	Armor Minimum O.D. (inches)
Coil	Reel			Coil	Reel		
2104S42-01	2104S60-01	12-2 Solid (brown, gray)	12 (solid green)	250'	1000'	110	0.495
2104S42-02	2104S60-02	12-2 Solid (orange, gray)	12 (solid green)	250'	1000'	110	0.495
2104S42-03	2104S60-03	12-2 Solid (yellow gray)	12 (solid green)	250'	1000'	110	0.495
2104S42-07	2104S60-07	12-2 Solid (purple, gray)	12 (solid green)	250'	1000'	110	0.495
2105S42-01	2105S60-01	12-3 Solid (brown, orange, gray)	12 (solid green)	250'	1000'	135	0.530
2105S42-02	2105S60-02	12-3 Solid (orange, yellow, gray)	12 (solid green)	250'	1000'	135	0.530
2105S42-03	2105S60-03	12-3 Solid (brown, yellow, gray)	12 (solid green)	250'	1000'	135	0.530
2105S42-07	2105S60-07	12-3 Solid (brown, purple, gray)	12 (solid green)	250'	1000'	135	0.530
2106S42-01	2106S60-01	12-4 Solid (brown, orange, yellow, gray)	12 (solid green)	250'	1000'	170	0.565
2158S42-01	2158S60-01	12-2 Stranded (brown, gray)	12 (stranded green)	250'	1000'	110	0.495
2158S42-02	2158S60-02	12-2 Stranded (orange, gray)	12 (stranded green)	250'	1000'	110	0.495
2158S42-03	2158S60-03	12-2 Stranded (yellow, gray)	12 (stranded green)	250'	1000'	110	0.495
2159S42-01	2159S60-01	12-3 Stranded (brown, orange, gray)	12 (stranded green)	250'	1000'	135	0.530
2160S42-01	2160S60-01	12-4 Stranded (brown, orange, yellow, gray)	12 (stranded green)	250'	1000'	170	0.565

MC Lite[®] is also available in 10 AWG and larger, see page 19.

NOTE: All dimensions and weights are subject to normal manufacturing tolerances. Other conductor colors available by special order.

MC TUFF® IG Isolated Ground Steel Cable – Lightweight Traditional Type MC Technical Specifications

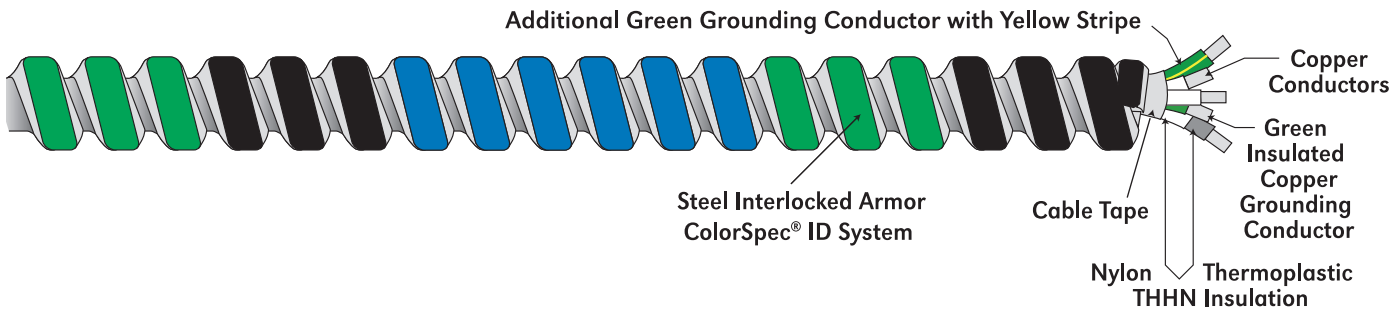

Specification Description

Specification	MC TUFF® IG ColorSpec® ID System
Armor	Galvanized Interlocking Steel* Strip (blue striped)
Conductors	Solid/Stranded Copper (see below)
Conductor Insulation	THHN/THWN (XHHW available by special order subject to lead time and minimum quantities)
Assembly Covering	Polypropylene Tape
Maximum Temperature Rating	90°C (dry)
Grounding	2 Grounding conductors, one solid green, one green with yellow stripe
Neutral Conductor	White
Maximum Voltage Rating	600V

References & Ratings

- UL 83, 1479, 1569, 1581, 2556, File Reference E80042
- NEC® 230.43, 250.118, 300.22(C), 392, 396, 330, 501, 502, 503, 530, 504, 505, 518, 520, 530, 645
- Cable Tray Rated, install per NEC®
- Federal Specification A-A-59544 (formerly J-C-30B)
- Meets all applicable OSHA and HUD Requirements
- UL Classified 1, 2, and 3 hour through (Fire) penetration product, R-14141
- Environmental Air-Handling Space Installation per NEC® 300.22(C)
- Made in USA of US and/or imported materials



Product Codes, Trade Sizes, Conductors, Packaging & Weights

Product Code Coil	Product Code Reel	Trade Size	Grounding Conductors AWG	Length (feet)		Approx. Weight/1000 Feet (lbs.)	Armor Minimum O.D. (inches)
				Coil	Reel		
120/208V							
Solid Conductor Colors							
1705B42T80	1705B60T80	12-2 Solid (black, white)	12 (solid green)	250'	1000'	186	0.530
1706B42T80	1706B60T80	12-3 Solid (black, red, white)	12 (solid green)	250'	1000'	223	0.565
1710B42T80	1710B60T80	12-4 Solid (black, blue, red, white)	12 (solid green)	250'	1000'	330	0.580
1708B42T80	1708B60T80	10-2 Solid (black, white)	10 (solid green)	250'	1000'	268	0.600
1709B42T80	1709B60T80	10-3 Solid (black, red, white)	10 (solid green)	250'	1000'	313	0.645
1711B42T80	1711B60T80	10-4 Solid (black, blue, red, white)	10 (solid green)	250'	1000'	391	0.670
1759B42T80	1759B60T80	12-2 Stranded (black, white)	12 (stranded green)	250'	1000'	191	0.530
120/208V							
Stranded Conductors							
1705B42T84	1705B60T84	12-2 Solid (red, white)	12 (solid green)	250'	1000'	186	0.530
1705B42T85	1705B60T85	12-2 Solid (blue, white)	12 (solid green)	250'	1000'	186	0.530
1708B42T84	1708B60T84	10-2 Solid (red, white)	10 (solid green)	250'	1000'	268	0.600
1708B42T85	1708B60T85	10-2 Solid (blue, white)	10 (solid green)	250'	1000'	268	0.600
2105S42-80	2105S60-80	12-2 Solid (black, white)	12 (solid green)	250'	1000'	268	0.600

NOTE: All dimensions and weights are subject to normal manufacturing tolerances.

* Aluminum available by special order and subject to lead times and minimum quantities.

SET SCREW CONNECTORS MAY BE USED WITH STEEL CABLES, SEE CONNECTOR CROSS-REFERENCE GUIDE FOR DETAILS.



MC Lite[®] IG Isolated Ground Aluminum Cable – Traditional Type MC Technical Specifications

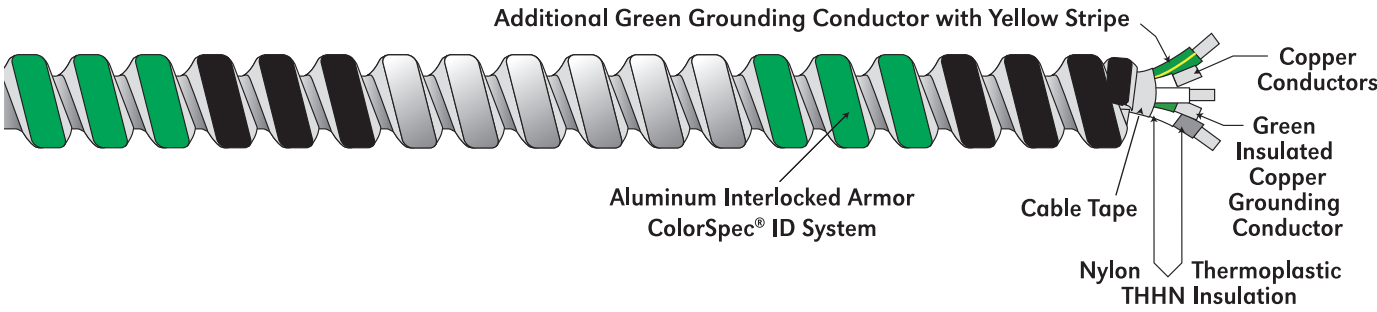

Specification Description

Specification	MC Lite [®] IG
Armor	Interlocking Aluminum Strip
Conductors	Solid/Stranded Copper
Conductor Insulation	THHN/THWN
Assembly Covering	Polypropylene Tape
Maximum Temperature Rating	90°C (dry)
Grounding	Two grounding means – 2 Insulated Green Grounding Conductors
Neutral Conductor	White for 120/208V circuits

Maximum Voltage Rating 600V

References & Ratings

- UL 83, 1479, 1569, 1581, 2556, File Reference E80042
- NEC[®] 230.43, 300.22(C), 392, 396, 330, 501, 502, 503, 530, 504, 505, 518, 520, 530, 645
- Federal Specification A-A-59544 (formerly J-C-30B)
- Meets all applicable OSHA and HUD Requirements
- May be surface mounted, fished and/or embedded in plaster
- Cable Tray Rated, install per NEC[®]
- UL Classified 1, 2, and 3 hour through (Fire) penetration product, R-14141
- Environmental Air-Handling Space Installation per NEC[®] 300.22(C)
- RoHS Compliant
- Made in USA of US and/or imported materials



Product Codes, Trade Sizes, Conductors, Packaging & Weights

Product Code Coil	Product Code Reel	Trade Size	Grounding Conductors AWG	Length (feet)		Approx. Weight/1000 Feet (lbs.)	Armor Minimum O.D. (inches)
				Coil	Reel		
120/208V							
Solid Conductor Colors							
2105S42-80	2105S60-80	12/2 Solid (black, white)	12 Solid (green, green/yellow)	250'	1000'	133	.550
2105S42-84	2105S60-84	12/2 Solid (red, white)	12 Solid (green, green/yellow)	250'	1000'	133	.550
2105S42-85	2105S60-85	12/2 Solid (blue, white)	12 Solid (green, green/yellow)	250'	1000'	133	.550
2106S42-80	2106S60-80	12/3 Solid (black, red, white)	12 Solid (green, green/yellow)	250'	1000'	161	.586
2110S42-80	2110S60-80	12/4 Solid (black, red, blue, white)	12 Solid (green, green/yellow)	250'	1000'	189	.623
2108-42-80	2108-60-80	10/2 Solid (black, white)	10 Solid (green, green/yellow)	250'	1000'	197	.622
2108-42-85	2108-60-85	10/2 Solid (blue, white)	10 Solid (green, green/yellow)	250'	1000'	197	.622
2108-42-84	2108-60-84	10/2 Solid (red, white)	10 Solid (green, green/yellow)	250'	1000'	197	.622
2109-42-80	2109-60-80	10/3 Solid (black, red, white)	10 Solid (green, green/yellow)	250'	1000'	240	.667
2111-42-80	2111-60-80	10/4 Solid (black, red, blue, white)	10 Solid (green, green/yellow)	250'	1000'	284	.713
120/208V							
Stranded Conductors							
2159S42-80	2159S60-80	12/2 Stranded (black, white)	12 Stranded (green, green/yellow)	250'	1000'	140	.573

NOTE: All dimensions and weights are subject to normal manufacturing tolerances.

* Aluminum available by special order and subject to lead times and minimum quantities.

MC-Plus[®] Neutral per Phase Cable – Type MC (Steel or Aluminum) (120/208V & 480Y/277V) Technical Specifications

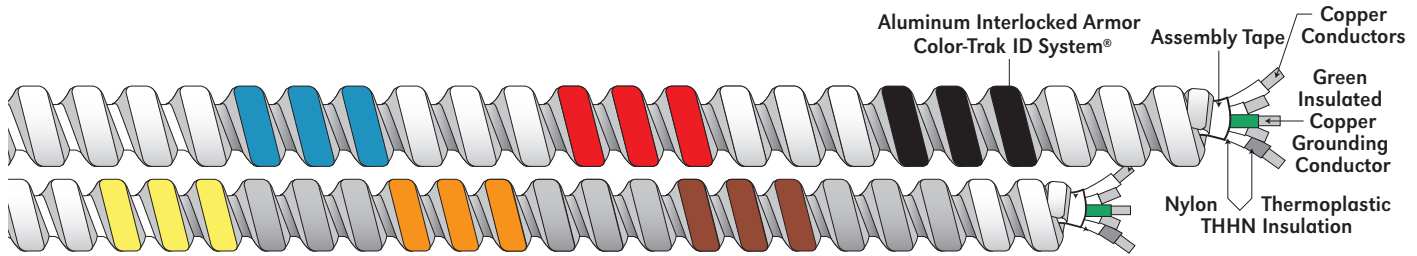

Specification Description

Specification	MC-Plus[®] with ColorSpec ID System[®]
Armor	Type MC with either galvanized steel or aluminum Interlocking strip (availability below), color-coded white armor
Conductors	Solid/Stranded Copper
Conductor Insulation	THHN/THWN
Assembly Covering	Polypropylene Tape
Maximum Temp. Rating	90°C (dry)
Grounding	One grounding means – Insulated Green Copper Grounding Conductor
Neutral Conductor	White 120/208V Grey 480Y/277V (see chart for id markings)

Maximum Voltage Rating 600V

References & Ratings

- UL 83, 1479, 1569, 1581, 2556, File Reference E80042
- NEC[®] 210.4(B), 230.43, 300.22(C), 330, 392, 396.10(A), 645
- Federal Specification A-A-59544 (formerly J-C-30B)
- Meets all applicable OSHA and HUD Requirements
- UL Classified 1, 2, and 3 hour through (Fire) penetration product, R-14141
- Environmental Air-Handling Space Installation per NEC[®] 300.22(C)
- Aluminum armored cables are RoHS Compliant
- Made in USA of US and/or imported materials
- Cable tray rated, install per NEC[®]



Product Codes, Trade Sizes, Conductors, Packaging & Weights

Product Code		Phase Conductor AWG	Neutral Conductor AWG	Grounding Conductor AWG	Approx. Weight/1000 Feet (lbs.)	Armor Nom. O.D. (inches)
250' Coil	1000' Reel					
MC-Plus (Steel)						
Solid 120/208V Colors						
3904-42-00	3904-60-00	12-2 (a)	12-2 (f)	12-1 (k)	233	0.586
3905-42-00	3905-60-00	12-3 (b)	12-3 (g)	12-1 (k)	306	0.620
3906-42-00	3906-60-00	12-4 (c)	12-4 (h)	12-1 (k)	380	0.698
3907-42-00	3907-60-00	10-2 (a)	10-2 (f)	10-1 (k)	326	0.667
3908-42-00	3908-60-00	10-3 (b)	10-3 (g)	10-1 (k)	433	0.710
3909-42-00	3909-60-00	10-4 (c)	10-4 (h)	10-1 (k)	570	0.856
MC-Plus (Steel)						
Solid 480Y/277V Colors						
3904-42-01	3904-60-01	12-2 (d)	12-2(i)	12-1(k)	233	0.586
3905-42-01	3905-60-01	12-3 (e)	12-3(j)	12-1(k)	306	0.620
3908-42-01	3908-60-01	10-3 (e)	10-3(j)	10-1(k)	433	0.710
MC-Plus Lite (Aluminum)						
Stranded 120/208V Colors						
3658-42-00	3658-60-00	12-2 (a)	12-2(f)	12-1 (k)	169	0.613
3659-42-00	3659-60-00	12-3 (b)	12-3(g)	12-1 (k)	241	0.650

NOTE: All dimensions and weights are subject to normal manufacturing tolerances.
* Aluminum available by special order and subject to lead times and minimum quantities.

Conductor Color Key;

- (a) black, red
- (b) black, red, blue
- (c) black "(1)", black "(2)", red "(1)", red "(2)"
- (d) brown, orange
- (e) brown, orange, yellow
- (f) white with "black" text, white with "red" text
- (g) white with "black" text, white with "red" text, white with "blue" text
- (h) white with "black (1)" text, white with "black (2)" text, white with "red (1)" text, & white with "red (2)" text
- (i) gray with "brown" text, gray with "orange" text
- (j) gray with "brown" text, gray with "orange" text, gray with "yellow" text
- (k) green

**For healthcare applications
See MC-Stat[®] Plus
see page 13.**

Super Neutral Cable®/Neutral per Phase or Oversized Neutral – Traditional Type MC Technical Specifications

Specification Description

Specification	Super Neutral Cable®
Armor	Galvanized Interlocking Steel* Strip
Conductors	Solid (8 AWG stranded)
Conductor Insulation	THHN/THWN
Assembly Covering	Polypropylene Tape
Maximum Temperature Rating	90°C (dry)
Grounding	One or more grounding conductors insulated green, see chart below
Neutral Conductors	Neutral per phase or oversized neutral configurations, white/white with phase stripe
Maximum Voltage Rating	600V

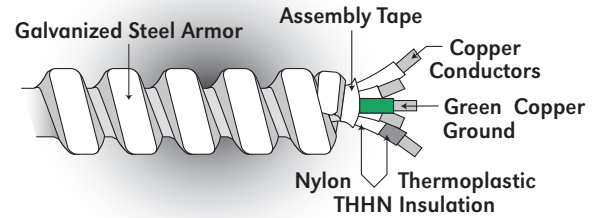

References & Ratings

- UL 83, 1479, 1569, 1581, 2556, File Reference E80042
- NEC® 230.43, 300.22(C), 392, 396.10(A), 330, 501, 502, 503, 530, 504, 505, 645
- Federal Specification A-A-59544 (formerly J-C-30B)
- Cable Tray Rated, install per NEC®
- UL Classified 1, 2, and 3 hour through (Fire) penetration product, R-14141
- Environmental Air Handling Spaces per NEC® 300.22(C)
- Conductors must be derated per NEC® Table 310.15(B)(3)(a)
- Made in USA of US and/or imported materials



Product Codes, Trade Sizes, Conductors, Packaging & Weights

250' Coil	Product Code			Phase Conductor AWG	Neutral Conductor AWG	Grounding Conductor AWG	Approx. Weight/1000 Feet (lbs.)	Armor Minimum O.D. (inches)
	500' Reel	750' Reel	1000' Reel					
Oversize Neutral Design								
2908-42-00	2908-45-00	2908-47-00	2908-60-00	12-1 Solid(a)	10-1(f)	12-1(k)	220	0.510
2909-42-00	2909-45-00	2909-47-00	2909-60-00	12-2 Solid(b)	10-1(f)	12-1(k)	260	0.540
2910-42-00	2910-45-00	2910-47-00	2910-60-00	12-3 Solid(c)	10-1(f)	12-1(k)	315	0.580
2907-42-00	2907-45-00	2907-47-00	2907-60-00	12-3 Solid(c)	10-1(f)	12-2(l)	345	0.590
2905-42-00	2905-45-00	2905-47-00	2905-60-00	12-3 Solid(c)	8-1(f)	12-1(k)	345	0.595
2918-42-00	2918-45-00	2918-47-00	2918-60-00	12-4 Solid(e)	10-2(g)	12-2(l)	435	0.660
2913-42-00	2913-45-00	2913-47-00	2913-60-00	10-3 Solid(c)	6-1(f)	10-1(k)	485	0.720
2970-42-00	2970-45-00	2970-47-00	2970-60-00	10-4 Solid(e)	8-2(g)	10-2(l)	628	0.800
Neutral Per Phase Design								
2916-42-00	2916-45-00	2916-47-00	2916-60-00	12-2 Solid(b)	12-2(h)	12-2(l)	335	0.580
2911-42-00	2911-45-00	2911-47-00	2911-60-00	12-3 Solid(c)	12-3(i)	12-2(l)	385	0.620
2960-42-00	2960-45-00	2960-47-00	2960-60-00	12-4 Solid(d)	12-3(j)	12-2(l)	420	0.659
2965-42-00	2965-45-00	2965-47-00	2965-60-00	10-2 Solid(b)	10-2(h)	10-2(l)	450	0.670
2912-42-00	2912-45-00	2912-47-00	2912-60-00	10-3 Solid(c)	10-3(i)	10-2(l)	545	0.720

NOTE: All dimensions and weights are subject to normal manufacturing tolerances.
 * Aluminum available by special order and subject to lead times and minimum quantities.

Super Neutral Cables are also available with application-specific combinations of circuit, neutral and grounding conductors.

- (a) black
- (b) black/red
- (c) black/red/blue
- (d) black/red/pink/tan
- (e) black/red/blue/pink
- (f) white
- (g) white/white with black stripe
- (h) white with black stripe/white with red stripe
- (i) white with black stripe/white with red stripe/white with blue stripe
- (j) white/white with pink stripe/white with tan stripe
- (k) green
- (l) green/green with yellow stripe

Parking Deck/Lot Cable™

Specification Description

Specification	Parking Deck/Lot Cable™
Armor & Jacket	Galvanized Interlocking Steel Strip with gray PVC jacket. Other jacket colors available by special order
Conductors	Solid/Stranded Copper (see below)
Conductor Insulation	THHN/THWN
Assembly Covering	Polypropylene Tape
Maximum Temperature Rating	90°C (dry); 75°C (wet)
Grounding	Insulated Green Copper Grounding Conductor
Neutral Conductors	White for 120/208V circuits Grey for 480Y/277V circuits
Maximum	600V

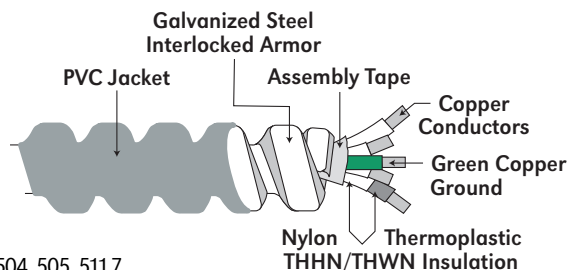

References & Ratings

- UL 83, 1479, 1569, 1581, 2556, File Reference E80042
- NEC® 230.43, 300.5, 392, 396, 10(A), 330, 501, 502, 503, 530, 504, 505, 511.7, 513.7(A), 514.7, 515.7(A), 516.7(A), 680.21(A)
- Federal Specification A-A-59544 (formerly JC-30B)
- UL listed for -40°C low temperature
- UL 1569 70,000 BTU and FT 4/ Vertical Tray Flame Tests IEEE 1203
- UL listed for Cable Tray use
- UL listed for Direct Burial including Concrete Encasement & wet locations
- UL listed Sunlight Resistant
- UL listed Oil Resistant II
- Hazardous locations up to Class I & II, Div. 2 and Class III, Div. 1 & 2 (NEC® Articles 501, 502, 503, 530)
- Cable tray rated, install per NEC®
- Wet locations per NEC® 330.10(11)(C)
- Made in USA of US and/or imported materials



Product Codes, Trade Sizes, Conductors, Packaging & Weights

Product Code Stock Items		Trade Size	Grounding Conductor AWG	Length (feet)		Approx. Weight/1000 Feet (lbs.)	Armor/Jacket Minimum O.D. (inches)
Coil	Reel			Coil	Reel		
120/208V							
2304-42-00	2304-60-00	12-2 Solid (black, white)	12 (solid green)	250'	1000'	280	0.495/0.605
2305-42-00	2305-60-00	12-3 Solid (black, red, white)	12 (solid green)	250'	1000'	320	0.530/0.640
2306-42-00	2306-60-00	12-4 Solid (black, blue, red, white)	12 (solid green)	250'	1000'	370	0.565/0.675
2307-42-00	2307-60-00	10-2 Solid (black, white)	10 (solid green)	250'	1000'	355	0.560/0.670
2308-42-00	2308-60-00	10-3 Solid (black, red, white)	10 (solid green)	250'	1000'	415	0.600/0.710
2309-42-00	2309-60-00	10-4 Solid (black, blue, red, white)	10 (solid green)	250'	1000'	480	0.645/0.755
2316-99-00	2316-99-00	8-3 Stranded (black, red, white)††	10 (stranded green)	—	—	560	0.685/0.795
2320-99-00	2320-99-00	6-3 Stranded (black, red, white)††	8 (stranded green)	—	—	805	0.855/0.965
480Y/277 Volt							
2304-42-01	2304-60-01	12-2 Solid (brown)	12 (solid green)	250'	1000'	280	0.495/0.605
2305-42-01	2305-60-01	12-3 Solid (brown, orange)	12 (solid green)	250'	1000'	320	0.530/0.640
2306-42-01	2306-60-01	12-4 Solid (brown, orange, yellow)	12 (solid green)	250'	1000'	370	0.565/0.675
2307-42-01	2307-60-01	10-2 Solid (brown)	10 (solid green)	250'	1000'	355	0.560/0.670
2308-42-01	2308-60-01	10-3 Solid (brown, orange)	10 (solid green)	250'	1000'	415	0.600/0.710
2309-42-01	2309-60-01	10-4 Solid (brown, orange, yellow)	10 (solid green)	250'	1000'	480	0.645/0.755

Note: All dimensions and weights subject to normal manufacturing tolerances.
Non-stock items require lead time and minimum quantity order.

See page 55 for details on Parking Deck Connectors.

Home Run Cable® – Traditional Type MC Technical Specifications

Specification Description

Specification	Home Run Cable®
Armor	Galvanized Interlocking Steel* Strip
Conductors	Solid Copper
Conductor Insulation	THHN/THWN
Assembly Covering	Polypropylene Tape
Maximum Temperature Rating	90°C (dry)
Grounding	One grounding means – Insulated Green Grounding Conductor (additional grounding conductors optional**)
Maximum Voltage Rating	600V

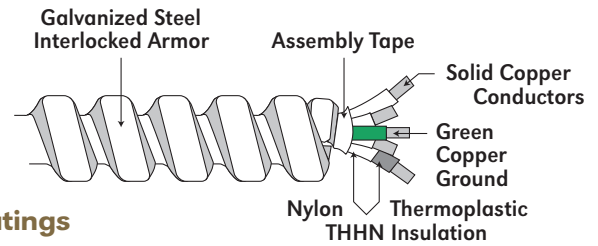

References & Ratings

- UL 83, 1479, 1569, 1581, 2556, File Reference E80042
- NEC® 230.43, 300.22(C), 392, 396, 330, 501, 502, 503, 530, 504, 505, 645
- Federal Specification A-A-59544 (formerly J-C-30B)
- Cable Tray Rated, install per NEC®
- UL Classified 1, 2, and 3 hour through (Fire) penetration product, R-14141
- Environmental Air-Handling Space Installation per NEC® 300.22(C)
- Conductors must be derated per NEC® Table 310.15(B)(3)(a)
- Made in USA of US and/or imported materials



Product Codes, Trade Sizes, Conductors, Packaging & Weights

Product Code Reel	Trade Size	Grounding Conductor AWG	Length (feet) Reel	Approx. Weight/1000 Feet (lbs.)	Armor Minimum O.D. (inches)
Stock Items					
1901-45-00	12-6 Solid	12 (solid green)	500'	345	0.580
1901-60-00	12-6 Solid	12 (solid green)	1000'	345	0.580
1902-45-00	12-8 Solid	12 (solid green)	500'	430	0.660
1902-60-00	12-8 Solid	12 (solid green)	1000'	430	0.660
1911-45-00	10-6 Solid	10 (solid green)	500'	485	0.670
1911-60-00	10-6 Solid	10 (solid green)	1000'	485	0.670
1905-45-00	10-8 Solid	10 (solid green)	500'	600	0.765
1905-60-00	10-8 Solid	10 (solid green)	1000'	600	0.765
1927-99-00	10-12 Solid	10 (solid green)	††	805	0.890
1928-99-00	10-16 Solid	10 (solid green)	††	995	0.980

Note: All dimensions and weights subject to normal manufacturing tolerances.
Non-stock items require lead time and minimum quantity.

* Aluminum available by special order and subject to lead times and minimum quantities.

** Special order, subject to lead times and minimum quantities.

†† Cut to order.

Armored Cable Derating Example

90°C RATED ARMORED CABLE 12 AWG WITH 4 COPPER CONDUCTORS.

- 1) Find conductor ampacity in NEC® Table 310.15(B)(16) - 12AWG, 90°C = 30 amperes
- 2) Find adjustment factor in NEC® Article 310.15(B)(3)(a) - 30 x .80 = 24 amperes

Stocking Sizes Color Codes:

Conductors 120/208V Colors

6	black, black/silver, red, red/silver, white, white/silver
8	black, black/silver, red, red/silver, blue, blue/silver, white, white/silver
12	3 black, 3 red, 3 blue, 3 white; each color numbered 1-3
16	4 black, 4 red, 4 blue, 4 white; each color numbered 1-4

Fire Alarm® Control Cable – Type MC – FPLP

Fully Plenum Rated Technical Specifications



Specification Description

Specification	Fire Alarm® Control Cable
Armor	Galvanized Interlocking Steel Strip (red-stripped)
Conductors	Solid Copper
Conductor Insulation	TFN 18 & 16 AWG and/or THHN 14 & 12 AWG
Assembly	Polyester Assembly Tape; Twisted Shielded: Laminated Aluminum/Mylar® Shield with Tinned Copper drain wire
Maximum Temperature Rating	FPLP: 105°C (dry) MC: 90°C (dry)
Grounding	One or more grounding conductors may be bare or insulated green, see chart below
Neutral Conductor	White
Maximum Voltage Rating	300V (FPLP) 600V (MC)

References & Ratings

- UL 66, 83, 1424, 1479, 1569, 1581, 2556, File Reference E80042
- NEC® 300.22(C), 392, 330, 430.2, 501, 502, 503, 530, 504, 505, 518, 530, 645, 725, 760, 760.154(A)
- Cable Tray Rated, install per NEC®
- Federal Specification A-A-59544 (formerly J-C-30B)
- UL Classified 1, 2, and 3 hour through (Fire) penetration product, R-14141
- NFPA 262 (formerly UL 910) Plenum Rated - Type FPLP
- Made in USA of US and/or imported materials

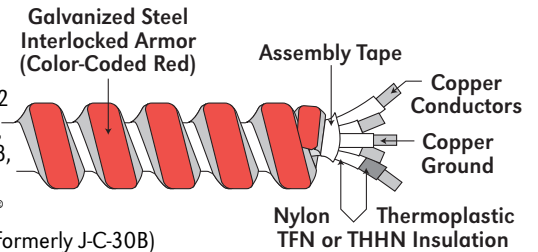

For the electrical properties of Fire Alarm® Control Cable and twists per foot information, see page 29.

Product Codes, Trade Sizes, Conductors, Packaging & Weights

Product Code				Trade Size	Grounding Conductor AWG	Approx. Weight/1000 Feet (lbs.)	Armor Minimum O.D. (inches)
250' Coil	500' Reel	750' Reel	1000' Reel				
Solid TFN							
1801R42-00	1801R45-00	1801R47-00	1801R60-00	18-2 Solid (black, white)	18 bare	115	0.410
1803R42-00	1803R45-00	1803R47-00	1803R60-00	18-4 Solid (black, white, red, blue)	18 bare	130	0.430
1805R42-00	1805R45-00	1805R47-00	1805R60-00	18-6 Solid (black, white, red, blue, yellow, orange)	18 bare	170	0.490
1807R42-00**	1807R45-00**	1807R47-00**	1807R60-00**	18-8 Solid (black, white, red, blue, yellow, orange, brown, purple)	18 bare	190	0.510
1810R42-00	1810R45-00	1810R47-00	1810R60-00	16-2 Solid (black, white)	16 bare	130	0.420
1813R42-00	1813R45-00	1813R47-00	1813R60-00	16-4 Solid (black, white, red, blue)	16 bare	155	0.440
1815R42-00**	1815R45-00**	1815R47-00**	1815R60-00**	16-6 Solid (black, white, red, blue, yellow, orange)	16 bare	205	0.510
1817R42-00**	1817R45-00**	1817R47-00**	—	16-8 Solid (black, white, red, blue, yellow, orange, brown, purple)	16 bare	230	0.520
Solid THHN							
1834R42-00	1834R45-00	1834R47-00	1834R60-00	14-2 Solid (black, white)	14 (solid green)	175	0.470
1837R42-00	1837R45-00	1837R47-00	1837R60-00	14-4 Solid (black, white, red, blue)	14 (solid green)	230	0.510
1823R42-00**	1823R45-00**	—	—	14-6 Solid (black, white, red, blue, yellow, orange)	14 (solid green)	250	0.520
1835R42-00	1835R45-00	1835R47-00	1835R60-00	12-2 Solid (black, white)	12 (solid green)	215	0.495
—	—	—	1835R60-05	12-2 Solid (blue, white)	12 (solid green)	—	—
1840R42-00	1840R45-00	—	1840R60-00	12-4 Solid (black, white, red, blue)	12 (solid green)	295	0.565
Twisted Shielded Pairs							
1850R42-00	1850R45-00	1850R47-00	1850R60-00	18-2 Solid (1 pair) (black, white)	18 tinned†	120	0.420
1827R42-00	1827R45-00	1827R47-00	1827R60-00	18-2 Solid (1 pair) (black, red) & shielded 14-2 Solid (1 pair) (black, white)	18 & 14 tinned† 2 pairs	290	0.640
1860R42-00	1860R45-00	1860R47-00	1860R60-00	16-2 Solid (1 pair) (black, white)	16 tinned†	135	0.430
1843R42-00	1843R45-00	1843R47-00	1843R60-00	16-4 Solid (2 pair) (black, white) (red, blue)	2-16 tinned†	160	0.450
1895R42-06	1895R45-06	1895R47-06	1895R60-06	16-2 Solid (1 pair) (black, red)	16 tinned† & 16 (solid green)	190	0.500
4901R42-00	4901R45-00	4901R47-00	4901R60-00	16-2 Solid (1 pair) (black, white) & un-shielded 12-2 Solid (1 pair) (black, red)	16 tinned† & 12 (solid green)	280	0.585
1828R42-00	1828R45-00	1828R47-00	1828R60-00	14-2 Solid (1 pair) (black, white)	16 tinned† & 14 (solid green)	170	0.470
—	—	—	1828R60-05	14-2 Solid (blue, white)	14 (solid green)	—	—
—	—	—	1895R60-05	16-2 Solid (blue, white)	16 (solid green)	—	—
1881R42-00	1881R45-00	—	—	14-4 Solid (2 pair) (black, red) (blue, white)	2-14 tinned† & 14 (solid green)	230	0.565
Specialty Colors							
1828R42-05	1828R45-05	1828R47-05	1828R60-05	14-2 Twisted Shielded Pair (blue/white)	14 (green+drain)	175	0.470
1834R42-05	1834R45-05	1834R47-05	1834R60-05	14-2 Solid (blue, white)	14 (solid green)	175	0.470
1834R42-06	1834R45-06	1834R47-06	1834R60-06	14-2 Solid (black, red)	14 (solid green)	175	0.470
1834R42-23	1834R45-23	1834R47-23	1834R60-23	14-2 Solid (orange, yellow)	14 (solid green)	175	0.470
1834R42-37	1834R45-37	1834R47-37	1834R60-37	14-2 Solid (brown, purple)	14 (solid green)	175	0.470
1834R42-44	1834R45-44	1834R47-44	1834R60-44	14-2 Solid (gray, gray*)	14 (solid green)	175	0.470
1837R42-05	1837R45-05	1837R47-05	1837R60-05	14-4 Solid (blue, blue*, white, white*)	14 (solid green)	230	0.510
1837R42-06	1837R45-06	1837R47-06	1837R60-06	14-4 Solid (black, black*, red, red*)	14 (solid green)	230	0.510
1895R42-06	1895R45-06	1895R47-06	1895R60-06	16-2 Twisted Shielded Pair (black/red)	16 (green+drain)	230	0.510

NOTE: All dimensions and weights are subject to normal manufacturing tolerances.

† Tinned copper drain/grounding conductor.

** Made to order only

Fire Alarm[®] Control Cable Performance Charts

Electrical Properties (ohms to neutral per 1000 feet)

Conductor Size AWG	XL, Reactance ¹	Rac, Resistance, 75°C ²	Z, Effective ³ Impedance
18	.047	7.77	6.24
16	.043	4.89	3.93
14	.042	3.07	2.48
12	.040	1.93	1.57

¹ In Steel Armor

² To correct for 90°C, multiply by 1.048

³ Effective Impedance is defined as $R \cos(\Theta) + X \sin(\Theta)$ where Θ is the power factor angle of the circuit. Effective impedance values shown in the table above are valid at 80% power factor.

Mutual Capacitance (pico farads per foot)

Conductor Size AWG	Twisted Pair ¹	Twisted Shielded Pair ²
18	30.0	47.3
16	33.5	54.8
14	36.3	60.7
12	38.8	66.4

¹ Between conductors

² Between one conductor and the other conductor(s) plus the shield

Inductance (L) to neutral, per 1000 feet is typically 0.0002mH for sizes 18 AWG through 250 kcmil

$$[*L = 0.1404 \text{ Log}_{10}(\text{GMD/GMR}) \times 10^{-3} \text{ Henrys to neutral per 1000 feet}]$$

Twists per Foot

Size	Total Number of Conductors Including Ground	Conductor Diameter	Length of Lay	Twists per Foot
18	3	0.08	2.8	4.3
18	4	0.08	3.2	3.8
18	5	0.08	3.3	3.7
16	3	0.09	3.2	3.8
16	4	0.09	3.6	3.3
16	5	0.09	3.7	3.3
14	3	0.105	3.7	3.3
14	4	0.105	4.2	2.9
14	5	0.105	4.3	2.8
12	3	0.125	4.4	2.7
12	4	0.125	5.0	2.4
12	5	0.125	5.1	2.4

Introduction Type AC Armored Cables

Type AC Armor Clad Cables – Uses Permitted:

The uses permitted for AC cable are governed by NEC® Article 320 and any applicable local codes. Please refer to NEC® Article 320 and your local authority having jurisdiction for additional information.

- Where not subject to physical damage for branch circuits and feeders in both exposed and concealed work and in cable trays where identified for such use
- In dry locations and embedded in plaster finish on brick or other masonry, except in damp or wet locations
- Run or fished in the air voids of masonry block or tile walls where the walls are not exposed or subject to excessive moisture or dampness
- Under raised floors, above suspended ceilings and in other environmental air handling spaces per NEC® 300.22(C)
- Aluminum armored cables are RoHS Compliant
- Made in USA of US and/or imported materials

Type AC Armor Clad Cables – Uses Not Permitted:

According to NEC® Article 320.12, AC cable can not be installed in the following locations:

- In theaters and similar locations, except as provided in NEC® Article 518, Places of Assembly
- In motion picture studios
- In locations classified as hazardous
- Where exposed to corrosive fumes or vapors
- On cranes or hoists
- In storage battery rooms
- In hoistways or on elevators, except as provided in NEC® Section 620.21
- In commercial garages where prohibited in 511.4 and 511.7

NEC® is a registered trademark of the National Electrical Code®.

For more information about the proper use and application of AC & MC cables, visit AFC University at www.afcweb.com/afcu



AFC manufactures two varieties of armored (Type AC) cables, standard AC cable and HCF, Health Care Facilities Cable, both featuring the ColorSpec ID System.

AC Cable: Type AC cable consists of 2 to 4 copper conductors in sizes 14 gauge to 1 AWG inside an interlocked metal armor of steel or aluminum construction.

A 16 AWG aluminum bonding wire is inside of, and in physical contact with, the metal armor providing a low-impedance fault-return path required for the operation of overcurrent protection devices. The 16 AWG bonding wire is unique to Type AC cable and allows the outer metal armor in conjunction with the bonding wire to be used as the equipment ground.

It is important to note that the bare bond wire is not an equipment grounding conductor. It is the bond wire that, in combination with the interlocked metal armor, provides a low impedance equipment grounding path. AFC color codes its standard AC cable black for easy identification.

HCF Health Care Facilities Cable: HCF is constructed in the same manner as standard AC cable with the addition of an insulated green grounding conductor. This additional ground allows HCF to be used in patient care areas of health care facilities (other than hazardous locations or emergency circuits in a health care setting) including hospitals, nursing homes, dental offices and medical centers per NEC® 517.13. The bond wire/armor combination provides the cable's equipment ground while the insulated green grounding conductor provides a redundant or isolated ground. AFC color codes HCF cable green for easy identification.

Type AC cable should be cut with an armored cable rotary cutting tool.

A rotary cutters help eliminate nicking and cutting of the conductors and removes the metal armor quickly and safely.



AC-90® & Type AC-Lite® Armored Cable

Galvanized Steel or Aluminum Armor Color-Coded Black*

Features & Benefits

Interlocking galvanized steel or aluminum strip

Easy to identify black armor

Integral bond wire/armor equipment ground fault path

UL classified for through-wall penetrations

Aluminum armored cables are RoHS Compliant

Made in USA of US and/or imported materials

Applications

Commercial, industrial, multi-residential branch circuits and feeder wiring, services for power, lighting, control and signal circuits. Exposed or concealed, surface mounted, embedded in plaster finish on brick or other masonry (except wet or damp locations), fished or run in air voids of masonry block or tile walls, under raised floors, above suspended ceilings and in other environmental air-handling spaces

Product Specifications

Refer to page:

AC-90® Steel Armored Cable (120/208V colors)	32
AC-90® Steel Armored Cable (480Y/277V colors)	32
AC-Lite® Aluminum Armored Cable (120/208V conductor colors, plain armor, no stripes)	33
AC-Lite® Aluminum Armored Cable (480Y/277V colors)	33



HCF-90® & HCF-Lite® Health Care Facilities Armored Cable

Galvanized Steel or Aluminum Armor Color-Coded Green*

Features & Benefits

Interlocking galvanized steel or aluminum strip

Easy to identify green armor

Full size green insulated copper grounding conductor plus armor/bond wire combination provides redundant ground or isolated grounding capability

UL classified for through-wall penetrations

Aluminum armored cables are RoHS Compliant

Made in USA of US and/or imported materials

Applications

Branch circuits and feeders in areas of patient care in hospitals, nursing homes, outpatient facilities, dental offices, clinics and medical centers (other than hazardous anesthetizing locations), data processing systems, Places of Assembly, under raised floors, above suspended ceilings and in other environmental air-handling spaces, exposed or concealed, surface mounted or fished, any application approved for AC cable requiring an isolated or redundant ground

Product Specifications

Refer to page:

HCF-90® Steel Health Care Facilities Cable (120/208V colors)	34
HCF-90® Steel Health Care Facilities Cable (480Y/277V colors)	34
HCF-Lite® Aluminum Health Care Facilities Cable (120/208V colors)	35
HCF-Lite® Aluminum Health Care Facilities Cable (480Y/277V colors)	35

* U.S. Patent #5,350,885, #5,468,914, #5,708,235, #5,557,071 & patent pending



AC-90[®] Steel Armored Cable – Type AC

(120/208V & 480Y/277V) Technical Specifications



Specification Description

Specification	AC-90 [®] ColorSpec [®] ID System
Armor	Galvanized Interlocking Steel Strip (black striped)
Conductors	Solid/Stranded Copper (see below)
Conductor Insulation	THHN
Conductor Insulation Covering	Moisture Resistant Fire Retardant Paper Wrap
Maximum Temperature Rating	90°C (dry)
Grounding	16AWG integral Bond Wire/Armor combination
Neutral Conductor	White
Maximum Voltage Rating	600V

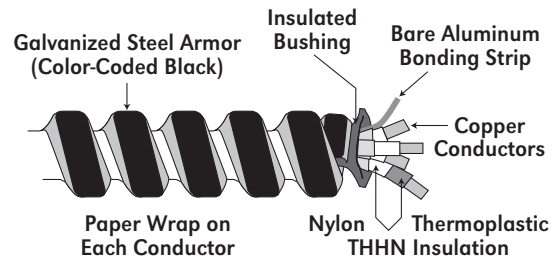

References & Ratings

- UL 4, 83, 1479, 1581, 2556, File Reference E7330
- NEC[®] 250.118(8), 300.22(C), 392, 320, 645
- Federal Specification A-A-59544 (formerly J-C-30B)
- Meets all applicable OSHA and HUD Requirements
- Cable Tray Rated, install per NEC[®]
- UL Classified 1, 2, and 3 hour through (Fire) penetration product, R-14141
- Environmental Air-Handling Space Installation per NEC[®] 300.22(C)
- Made in USA of US and/or imported materials



Product Codes, Trade Sizes, Conductors, Packaging & Weights

Product Code Coil	Reel	Trade Size	Length (feet)		Approx. Weight/1000 Feet (lbs.)	Armor Minimum O.D. (inches)
			Coil	Reel		
120/208V						
1401N42-00	1401N60-00	14-2 Solid (black, white)	250'	1000'	180	0.433
1402N42-00	1402N60-00	14-3 Solid (black, red, white)	250'	1000'	200	0.453
1403N42-00	1403N60-00	14-4 Solid (black, red, blue, white)	250'	1000'	250	0.486
1404N42-00	1404N60-00	12-2 Solid (black, white)	250'	1000'	210	0.467
1405N42-00	1405N60-00	12-3 Solid (black, red, white)	250'	1000'	245	0.489
1406N42-00	1406N60-00	12-4 Solid (black, red, blue, white)	250'	1000'	290	0.520
1407N32-00	1407N60-00	10-2 Solid (black, white)	125'	1000'	250	0.476
1407N42-00	—	10-2 Solid (black, white)	250'	—	250	0.476
1408N32-00	1408N60-00	10-3 Solid (black, red, white)	125'	1000'	295	0.500
1408N42-00	—	10-3 Solid (black, red, white)	250'	—	250	0.476
1409N32-00	1409N60-00	10-4 Solid (black, red, blue, white)	125'	1000'	380	0.541
1409N42-00	—	10-4 Solid (black, red, blue, white)	250'	—	250	0.476
1415-40-00	1415-45-00	8-2 Stranded (black, white)	200'	500'	345	0.604
1416-40-00	1416-45-00	8-3 Stranded (black, red, white)	200'	500'	420	0.637
1417-32-00	1417-45-00	8-4 Stranded (black, red, blue, white)	125'	500'	515	0.695
1419-32-00	1419-45-00	6-2 Stranded (black, white)	125'	500'	445	0.700
1420-32-00	1420-45-00	6-3 Stranded (black, red, white)	125'	500'	560	0.739
1421-30-00	1421-45-00	6-4 Stranded (black, red, blue, white)	100'	500'	685	0.807
1424-30-00	1424-45-00	4-3 Stranded (black, red, white)	100'	500'	800	0.885
1425-30-00	1425-45-00	4-4 Stranded (black, red, blue, white)	100'	500'	995	0.971
1428-30-00	1428-45-00	3-3 Stranded (black, red, white)	100'	500'	940	0.990
1429-30-00	1429-45-00	3-4 Stranded (black, red, blue, white)	100'	500'	1180	1.085
1426-30-00	1426-45-00	2-3 Stranded (black, red, white)	100'	500'	1095	1.014
1427-30-00	1427-45-00	2-4 Stranded (black, red, blue, white)	100'	500'	1380	1.115
480Y/277V						
1404N42-01	1404N60-01	12-2 Solid (brown)	250'	1000'	210	0.467
1404N42-02*	1404N60-02*	12-2 Solid (orange)	250'	1000'	210	0.467
1405N42-01	1405N60-01	12-3 Solid (brown, orange)	250'	1000'	245	0.489
1405N42-02*	1405N60-02*	12-3 Solid (orange, yellow)	250'	1000'	245	0.489
1406N42-01*	1406N60-01*	12-4 Solid (brown, orange, yellow)	250'	1000'	290	0.520

NOTE: All dimensions and weights are subject to normal manufacturing tolerances.

* Made to order only

AFC Cable System's ColorSpec[®] ID System is available on 14-2 through 10-4

See page 45 for bond wire termination details.

AC-Lite[®] Aluminum Armored Cable – Type AC (120/208V & 480Y/277V) Technical Specifications Plain Armor



Specification Description

Specification	AC-Lite [®]
Armor	Interlocking Aluminum Strip (silver or black striped)
Conductors	Solid/Stranded Copper (see below)
Conductor Insulation	THHN
Conductor Insulation Covering	Moisture resistant Fire Retardant Paper Wrap
Maximum Temperature Rating	90°C (dry)
Grounding	16AWG integral Bond Wire/Armor combination
Neutral Conductor	White 120/208V / Grey 480Y/277V
Maximum Voltage Rating	600V

References & Ratings

- UL 4, 83, 1479, 1581, 2556, File Reference E7330
- NEC[®] 250.118(8), 300.22(C), 392, 320, 645
- Federal Specification A-A-59544 (formerly J-C-30B)
- Meets all applicable OSHA and HUD Requirements
- Cable Tray Rated, install per NEC[®]
- UL Classified 1, 2, and 3 hour through (Fire) penetration product, R-14141
- Environmental Air-Handling Space Installation per NEC[®] 300.22(C)
- Aluminum armored cables are RoHS Compliant
- Made in USA of US and/or imported materials

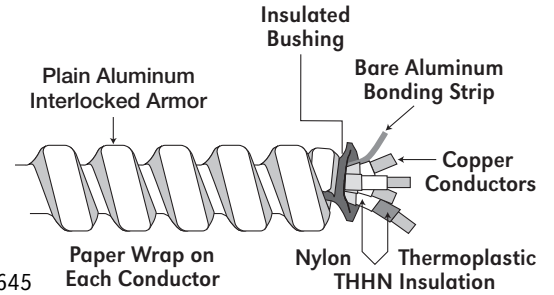

Product Codes, Trade Sizes, Conductors, Packaging & Weights

Product Code		Trade Size	Length (feet)		Approx. Weight/1000 Feet (lbs.)	Armor Minimum O.D. (inches)
Coil	Reel		Coil	Reel		
120/208V						
2701-42-00	2701-60-00	14-2 Solid (black, white)	250'	1000'	80	0.433
2702-42-00	2702-60-00	14-3 Solid(black, red, white)	250'	1000'	100	0.453
2703-42-00	2703-60-00	14-4 (black, red, blue, white)	250'	1000'	120	0.486
2704-42-00	2704-60-00	12-2 Solid (black, white)	250'	1000'	100	0.467
2705-42-00	2705-60-00	12-3 Solid(black, red, white)	250'	1000'	130	0.489
2706-42-00	2706-60-00	12-4 (black, red, blue, white)	250'	1000'	155	0.520
–	2707-60-00	10-2 Solid (black, white)	–	1000'	135	0.476
–	2708-60-00	10-3 Solid(black, red, white)	–	1000'	180	0.500
–	2709-60-00	10-4 (black, red, blue, white)	–	1000'	225	0.541
2707-42-00	–	10-2 Solid (black, white)	250'	–	135	0.476
2708-42-00	–	10-3 Solid(black, red, white)	250'	–	180	0.500
2709-42-00	–	10-4 (black, red, blue, white)	250'	–	225	0.541
2715-40-00	2715-45-00	8-2 Stranded (black, white)	200'	500'	210	0.604
2716-40-00	2716-45-00	8-3 Stranded(black, red, white)	200'	500'	275	0.637
2720-32-00	2720-45-00	6-3 Stranded (black, red, blue, white)	125'	500'	395	0.739
2724-30-00	2724-45-00	4-3 Stranded(black, red, white)	100'	500'	590	0.885
2725-30-00	2725-45-00	4-4 Stranded (black, red, blue, white)	100'	500'	760	0.971
2728-30-00	2728-45-00	3-3 Stranded(black, red, white)	100'	500'	720	0.990
2729-30-00	2729-45-00	3-4 Stranded (black, red, blue, white)	100'	500'	930	1.085
2726-30-00	2726-45-00	2-3 Stranded(black, red, white)	100'	500'	885	1.014
2727-30-00	2727-45-00	2-4 Stranded (black, red, blue, white)	100'	500'	1150	1.115
480Y/277V						
2704N42-01	2704N60-01	12-2 Solid (brown)	250'	1000'	100	0.467
2705N42-01	2705N60-01	12-3 Solid (brown, orange)	250'	1000'	130	0.489

NOTE: All dimensions and weights are subject to normal manufacturing tolerances. Other conductor colors available by special order. Not to be used with set screw type fittings or on DC circuits.

See page 45 for bond wire termination details.

HCF-90[®] Steel Healthcare Facilities Cable – (120/208V & 480Y/277V) Technical Specifications



Specification Description

Specification	HCF-90 [®] ColorSpec [®] ID System
Armor	Galvanized Interlocking Steel Strip (green striped)
Conductors	Solid Copper
Conductor Insulation	THHN
Conductor Insulation Covering	Moisture resistant Fire Retardant Paper Wrap
Maximum Temperature Rating	90°C (dry)
Grounding	16 AWG integral Bond Wire/Armor combination and insulated green copper 250.118(B) grounding conductor 250.118(1)
Neutral Conductor	White 120/208V / Grey 480Y/277V
Maximum Voltage Rating	600V

References & Ratings

- UL 4, 83, 1479, 1581, 2556, File Reference E7330
- NEC[®] 250.118(8), 300.22(C), 392, 320, 517.13, 518, 645
- Federal Specification A-A-59544 (formerly J-C-30B)
- Meets all applicable OSHA and HUD Requirements
- Cable Tray Rated, install per NEC[®]
- UL Classified 1, 2, and 3 hour through (Fire) penetration product, R-14141
- Environmental Air-Handling Space Installation per NEC[®] 300.22(C)
- Made in USA of US and/or imported materials

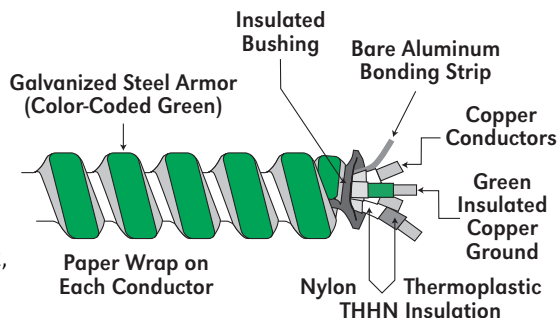

Product Codes, Trade Sizes, Conductors, Packaging & Weights

Product Code	Coil	Reel	Trade Size	Grounding Conductor AWG	Length (feet)		Approx. Weight/1000 Feet (lbs.)	Armor Minimum O.D. (inches)
					Coil	Reel		
120/208V								
1504G42-00		1504G60-00	12-2 Solid (black,white)	12 solid	250'	1000'	220	0.489
1505G42-00		1505G60-00	12-3 Solid (black,red,white)	12 solid	250'	1000'	260	0.520
1506G42-00		1506G60-00	12-4 Solid (black,red, blue,white)	12 solid	250'	1000'	300	0.545
1507G42-00		1507G60-00	10-2 Solid (black,white)	10 solid	250'	—	290	0.500
1508G42-00		1508G60-00	10-3 Solid (black,red,white)	10 solid	250'	—	345	0.541
1509G42-00		1509G60-00	10-4 Solid (black,red, blue,white)	10 solid	250'	—	405	0.587
120/208V Specialty Colors								
1504G42-04		1504G60-04	12-2 Solid (red, white)	12 solid	250'	1000'	220	0.489
1504G42-05		1504G60-05	12-2 Solid (blue, white)	12 solid	250'	1000'	220	0.489
480Y/277V								
1504G42-01		1504G60-01	12-2 Solid (brown)	12 solid	250'	1000'	220	0.489
1504G42-02		1504G60-02	12-2 Solid (orange)	12 solid	250'	1000'	220	0.489
1504G42-03		1504G60-03	12-2 Solid (yellow)	12 solid	250'	1000'	220	0.489
1505G42-01		1505G60-01	12-3 Solid (brown, orange)	12 solid	250'	1000'	260	0.520
1506G42-01		1506G60-01	12-4 Solid (brown, orange, yellow)	12 solid	250'	1000'	300	0.545

NOTE: All dimensions and weights are subject to normal manufacturing tolerances.
Sizes 14 AWG, 8 AWG, & larger are available by special order and subject to lead time and minimum quantities.

**Emergency circuits require special consideration in healthcare settings.
Review NEC[®] 517.30 (C)(3)(3) for guidance on the use of HCF cables on emergency circuits.**

See page 45 for bond wire termination details.

HCF-Lite® Aluminum Healthcare Facilities Cable – Type AC (120/208V & 480Y/277V) Technical Specifications



Specification Description

Specification	HCF-Lite® ColorSpec ID System®
Armor	Aluminum Interlocking Strip (green striped)
Conductors	Solid/Stranded Copper (see below)
Conductor Insulation	THHN
Conductor Insulation Covering	Moisture resistant Fire Retardant Paper Wrap
Maximum Temperature Rating	90°C (dry)
Grounding	16 AWG integral Bond Wire/Armor combination and insulated green copper 250.118(B) grounding conductor 250.118(1)
Neutral Conductor	White 120/208V / Grey 480Y/277V
Maximum Voltage Rating	600V

References & Ratings

- UL 4, 83, 1479, 1581, 2556, File Reference E7330
- NEC® 250.118(8), 300.22(C), 392, 320, 517.13, 518, 645
- Federal Specification A-A-59544 (formerly J-C-30B)
- Meets all applicable OSHA and HUD Requirements
- Cable Tray Rated, install per NEC®
- UL Classified 1, 2, and 3 hour through (Fire) penetration product, R-14141
- Environmental Air-Handling Space Installation per NEC® 300.22(C)
- Aluminum armored cables are RoHS Compliant
- Made in USA of US and/or imported materials

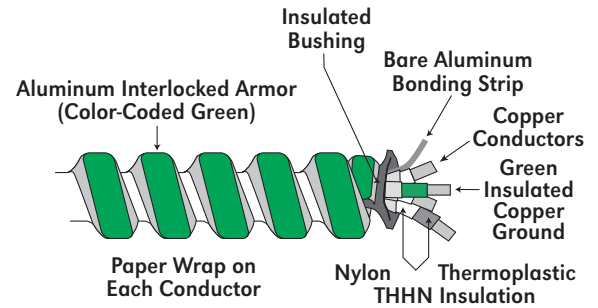

Product Codes, Trade Sizes, Conductors, Packaging & Weights

Product Code Coil	Product Code Reel	Trade Size	Grounding Conductor AWG	Length (feet)		Approx. Weight/1000 Feet (lbs.)	Armor Minimum O.D. (inches)
				Coil	Reel		
120/208V							
2804G42-00	2804G60-00	12-2 Solid (black,white)	12 solid	250'	1000'	130	0.489
2805G42-00	2805G60-00	12-3 Solid (black,red,white)	12 solid	250'	1000'	155	0.520
2806G42-00	2806G60-00	12-4 Solid (black,red, blue,white)	12 solid	250'	1000'	185	0.545
2858G42-00	2858G60-00	12-2 Stranded (black,white)	12 stranded	250'	1000'	130	0.489
2859G42-00	2859G60-00	12-3 Stranded (black,red,white)	12 stranded	250'	1000'	155	0.520
2860G42-00	2860G60-00	12-4 Stranded (black,red, blue,white)	12 stranded	250'	1000'	185	0.545
2807G42-00	2807G60-00	10-2 Solid (black,white)	10 solid	250'	1000'	180	0.500
2808G42-00	2808G60-00	10-3 Solid (black,red,white)	10 solid	250'	1000'	225	0.541
2809G42-00	2809G60-00	10-4 Solid (black,red, blue,white)	10 solid	250'	1000'	275	0.587
120/208V Specialty Colors							
2804G42-04	2804G60-04	12-2 Solid (red, white)	12 solid	250'	1000'	130	0.489
2804G42-05	2804G60-05	12-2 Solid (blue, white)	12 solid	250'	1000'	130	0.489
480Y/277V							
2804G42-01	2804G60-01	12-2 Solid (brown)	12 solid	250'	1000'	130	0.489
2804G42-02	2804G60-02	12-2 Solid (orange)	12 solid	250'	1000'	130	0.489
2804G42-03	2804G60-03	12-2 Solid (yellow)	12 solid	250'	1000'	130	0.489
2805G42-01	2805G60-01	12-3 Solid (brown, orange)	12 solid	250'	1000'	155	0.5201
2806G42-01	2806G60-01	12-4 Solid (brown, orange, yellow)	12 solid	250'	1000'	185	0.545

NOTE: All dimensions and weights are subject to normal manufacturing tolerances.
 Not to be used with set screw type fittings or on DC circuits.
 Sizes 14 AWG, 8 AWG, & larger are available by special order and subject to lead time and minimum quantities.

**Emergency circuits require special consideration in healthcare settings.
 Review NEC® 517.30 (C)(3)(3) for guidance on the use of HCF cables on emergency circuits.**

See page 45 for bond wire termination details.

NEC® Code References

Most Frequently used for installing MC and AC Cables

The following is a quick reference list of the most frequently used National Electrical Code® sections used when installing armored cables. This is not intended to be an all inclusive list. All local electrical codes and standards must also be reviewed prior to and during electrical installations to insure conformity to those safety standards which may amend the National Electrical Code®.

NEC 330 - Metal-Clad Cable: Type MC

NEC 320 - Armored Cable: Type AC

NEC 517 - Health Care Facilities

NEC 518 - Assembly Occupancies

NEC 645 - Information Technology Equipment

NEC 250.118 - Types of Equipment Grounding Conductors

NEC 300.22(C) - Other Spaces Used for Environmental Air (Plenums)

NEC 530 - Motion Picture and Television Studios and Similar Locations

NEC 210.4(B) - Multiwire Branch Circuit - Disconnecting Means

NEC 392 - Cable Trays

NEC Table 310.15(B)(3)(a) - Adjustment Factors for More Than Three Current-Carrying Conductors in a Raceway or Cable





NEC 310.10 - Locations (A) Dry Locations, (B) Dry and Damp Locations, (C) Wet Locations

NEC Table 310.15(B)16 - Allowable Ampacities of Insulated Conductors rated up to and including 2000V

NEC 500 - Hazardous (Classified) Locations, Classes I, II, and III, Division 1 and 2

NEC 760 - Fire Alarm Systems

Comparison of MC, AC & HCF Cables

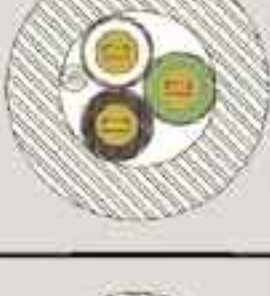
	TYPE MC CABLE				TYPE AC CABLE			
PRODUCT FAMILY	MC TUFF® & MC LITE®	MC-Quik® & MC-Quik® Lite	MC-Stat® & MC-Stat® Lite	AC-90® & AC-LITE®	HCF-90® & HCF-LITE®			
MAXIMUM NUMBER OF CONDUCTORS	No Limit	No Limit	No Limit	4 circuit conductors	4 circuit conductors plus grounds			
SIZE OF COPPER CONDUCTORS	18 AWG to 2000 kcmil	14 AWG to 5 AWG	14 AWG to 5 AWG	14 AWG to 1 AWG	14 AWG to 1 AWG			
GROUNDING	Insulated equipment grounding conductor	Full sized bare aluminum bond/ground conductor and armor combination	Full size bare aluminum bond/ground wire and armor combination, plus a green insulated equipment grounding conductor.	16 AWG bare aluminum bond wire and armor combination	16 AWG bare aluminum bond wire and armor combination, plus a green insulated equipment grounding conductor.			
CONDUCTOR WRAPPING	Conductors have an overall polypropylene assembly tape.	Individual conductors have an extruded protective covering. No overall assembly tape.	Individual conductors have an extruded protective covering. No overall assembly tape.	Individual conductors are wrapped in a moisture resistant, fire retardant paper	Individual conductors are wrapped in a moisture resistant, fire retardant paper			
TESTED TO UL STANDARD	UL 1569	UL 1569	UL 1569	UL 4	UL 4			
12-2 EXAMPLES								

AFC ColorSpec® ID System

Comparison of MC, AC & HCF Cables

	2 conductors with armor/braid ground	3 conductors with armor/braid ground	4 conductors with armor/braid ground
MC-Quik® 120/208V	Single Phase	Two Phase	Three Phase
MC-Quik® 480Y/277V	Single Phase	Two Phase	Three Phase
MC-Stat® 120/208V	2 conductors with armor/braid ground & green ground	3 conductors with armor/braid ground & green ground	4 conductors with armor/braid ground & green ground
MC-Stat® 480Y/277V	Single Phase	Two Phase	Three Phase
MC Tuff® 120/208V	2 conductors with ground	3 conductors with ground	4 conductors with ground
MC Tuff® 480Y/277V	Single Phase	Two Phase	Three Phase
MC Tuff® IG 120/208V	Single Phase	Two Phase	Three Phase
MC Lite® 120/208V	2 conductors with ground	3 conductors with ground	4 conductors with ground
MC Lite® 480Y/277V	Single Phase	Two Phase	Three Phase
MC Lite® IG 120/208V	Single Phase	Two Phase	Three Phase
MC-Plus® 120/208V	2 conductors with ground	3 conductors with ground	4 conductors with ground
MC-Plus® 480Y/277V			MC-Plus® also available with 4 conductors; 3 neutrals with ground
AC-90® 120/208V	2 core with armor/braid wire ground	3 core with armor/braid wire ground	4 core with armor/braid wire ground
AC-90® 480Y/277V	Single Phase	Two Phase	Three Phase
HCF-90® 120/208V	2 conductors with armor/braid ground & green ground	3 conductors with armor/braid ground & green ground	3 conductors with armor/braid ground & green ground
HCF-90® 480Y/277V	Single Phase	Two Phase	Three Phase

AFC ColorSpec® ID System

MC

AC

Bare Armored Ground Cable Technical Specifications

Specification Description

Specification	Bare Armored Ground
Armor	Galvanized interlocked steel
Conductors	Solid 8 AWG and 6 AWG 7 Strand 4 AWG

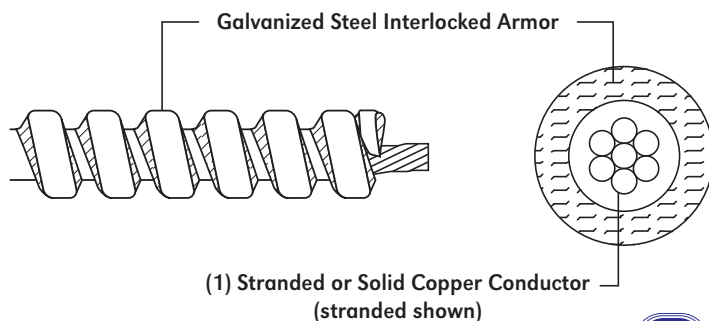

References & Ratings

- UL 467 E82631
- NEC® 250.118

Product Codes, Trade Sizes, Conductors, Packaging & Weights

Product Code		Trade Size	Length (feet)		Approx. Weight/1000 Feet (lbs.)	Armor Minimum O.D. (inches)
Coil	Reel		Coil	Reel		
1301-42-00	1301-60-00	8-1 Solid	250'	1000'	136	tba
1302-42-00	1302-60-00	6-1 Solid	250'	1000'	168	tba
1303-42-00	1303-45-00	4-1 Stranded	250'	500'	241	tba

NOTE: All dimensions and weights are subject to normal manufacturing tolerances

AFC Metallic Whips Type UL

Specification Description

Specification	UL Whips
Conduit	Galvanized Type RW Steel Flexible Metal Conduit
Conductors	THHN 14AWG and Larger 18 & 16AWG TFN/TFFN
Maximum Temperature Rating	90°C (dry)
Grounding	NEC® 250.118(5) many styles with green grounding conductor
Maximum Voltage Rating	600V
Connectors	Screw-in die cast connector

References & Ratings

- UL File Reference E96572
- NEC® 410, 430, 440, 250, 348

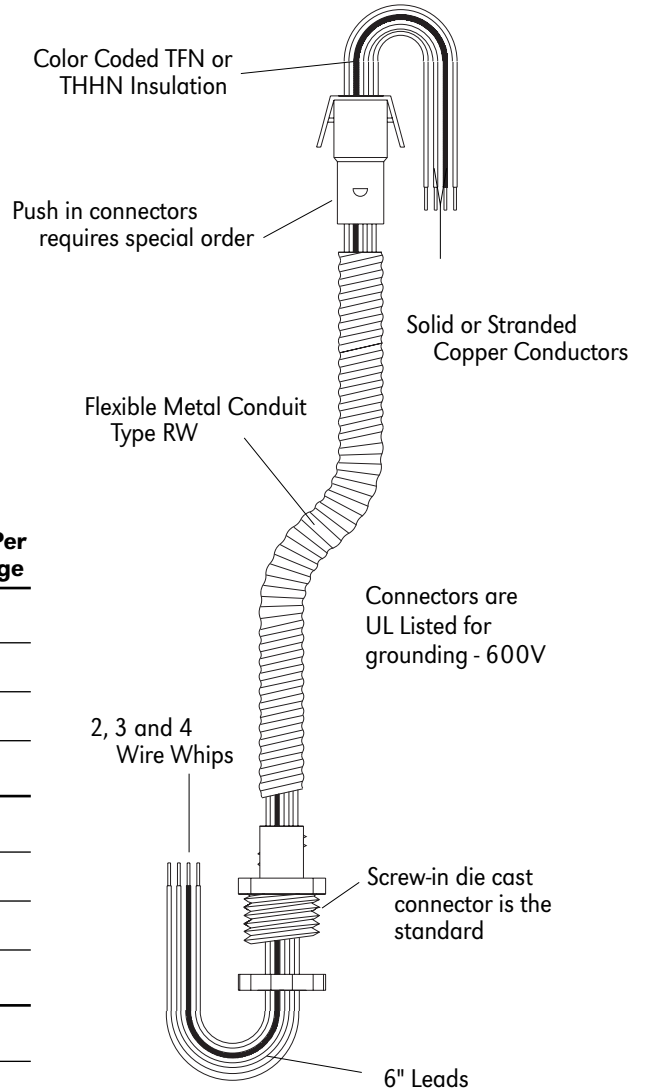

Solid Conductors

Description	Part Number	Units Per Package
3/8 F x 6	18-2 4521-21	30
	18-2 4521-30	100
	16-2 4511-21	30
	16-2 4511-30	100
	14-2 4501-21	30
	14-2 4501-30	100
	12-2 4578-21	30
	12-2 4578-30	100
3/8 F x 6	18-3 4522-21	30
	18-3 4522-30	100
	16-3 4512-21	30
	16-3 4512-30	100
	14-3 4502-21	30
	14-3 4502-30	100
	12-3 4579-21	30
	12-3 4579-30	100
3/8 F x 6	18-4 4523-21	30
	18-4 4523-30	100
	16-4 4513-21	30
	16-4 4513-30	100
	14-4 4503-21	30
	14-4 4503-30	100
	12-4 4580-21	30
	12-4 4580-30	100
1/2 F x 6	14-2 4701-15	15
	14-2 4701-24	50
	12-2 4704-15	15
	12-2 4704-24	50
1/2 F x 6	14-3 4702-15	15
	14-3 4702-24	50
	12-3 4705-15	15
	12-3 4705-24	50
1/2 F x 6	14-4 4703-15	15
	14-4 4703-24	50
	12-4 4706-15	15
	12-4 4706-24	50

Stranded Conductors

Description	Part Number	Units Per Package
3/8 F x 6	18-2 4621-21	30
	18-2 4621-30	100
	16-2 4611-21	30
	16-2 4611-30	100
	14-2 4601-21	30
	14-2 4601-30	100
	12-2 4678-21	30
	12-2 4678-30	100
3/8 F x 6	18-3 4622-21	30
	18-3 4622-30	100
	16-3 4612-21	30
	16-3 4612-30	100
	14-3 4602-21	30
	14-3 4602-30	100
	12-3 4679-21	30
	12-3 4679-30	100
3/8 F x 6	18-4 4623-21	30
	18-4 4623-30	100
	16-4 4613-21	30
	16-4 4613-30	100
	14-4 4603-21	30
	14-4 4603-30	100
	12-4 4680-21	30
	12-4 4680-30	100
1/2 F x 6	14-2 4801-15	15
	14-2 4801-24	50
	12-2 4804-15	15
	12-2 4804-24	50
1/2 F x 6	14-3 4802-15	15
	14-3 4802-24	50
	12-3 4805-15	15
	12-3 4805-24	50
1/2 F x 6	14-4 4803-15	15
	14-4 4803-24	50
	12-4 4806-15	15
	12-4 4806-24	50

Whips come with standard 120/208V color THHN conductors but are also available with 480Y/277V colors if specified on order. 3/8" whips have screw in die cast connectors on the 18AWG, 16AWG & 14AWG and set screw die cast for the 12AWG. 1/2" whips have screw in die cast connectors.

2 conductor is black, white.

3 conductor is black, white, green.

4 conductor is black, white, red, green.

All whips are available in barrels and cartons.

AFC Non-Metallic Whips Type UL

Specification Description

Specification	Non-Metallic Whips
Conduit	Type LFNC-B, Non-metallic Liquidtight
Conductors	THHN/THWN 8 & 10 AWG
Maximum Temperature Rating	90°C (dry) 75°C (wet)
Grounding	NEC® 250.118(1)
Maximum Voltage Rating	600V

References & Ratings

- UL File Reference E96572
- NEC® 410, 430, 440, 250, 356
- RoHS Compliant



Non-metallic Liquidtight Whips (Standard Configurations)

Product Code	Trade Size (inches)	Length (feet)	No. of Cond.	AWG (cond. size)	Put Up
8014	1/2"	4'	3	10	10 per box
8015	1/2"	6'	3	10	10 per box
8016	3/4"	4'	3	8	10 per box
8017	3/4"	6'	3	8	8 per box
8021	1/2"	4'	3	10	20 bulk
8022	1/2"	6'	3	10	15 bulk
8023	3/4"	4'	3	8	10 bulk
8024	3/4"	6'	3	8	10 bulk

Whips come with Black, Red, Green THHN/THWN conductors.

Other conductor colors available by special request.

All whips come with one straight non-metallic liquidtight connector and one 90° angle non-metallic liquidtight connector.

MSDS Sheet for AFC Cables



SINCE 1926

AFC

CABLE SYSTEMS®

A PART OF  **atkore**
INTERNATIONAL

272 Duchaine Boulevard, New Bedford, MA 02745

• Telephone: 508-998-1131 • 800-757-6996 • Fax: 508-998-1447 • www.afcweb.com

**Subject: Material Safety Data Sheets (MSDS)
AFC Cable Products**

An official notice from OSHA confirms that the electrical products (cables, conduits, fittings, modular wiring, etc.) manufactured by AFC come under the classification of "Articles" under the Hazard Communication Standard. By definition, an article is defined as a product that does not "release or otherwise result in exposure to hazardous chemicals under normal conditions of use." Consequently, the electrical products manufactured by AFC do not require Material Safety Data Sheets.

The lubricants used in the manufacturing of conduits and cables are also covered by OSHA as non-hazardous and are primarily vegetable based materials.

Please contact us if you have any additional questions.

Installation Instructions for Traditional Type AC & MC Cables

Armored cable (Type AC) and metal clad cable (Type MC) provide a fast and efficient way of wiring both new construction and remodeling work. Their flexible metal armor provides mechanical protection of the electrical conductors while enabling them to bend around corners. The cables are pre-wired at the factory eliminating the need to pull conductors into a raceway, which in turn greatly reduces the possibility of conductor damage.

The National Electrical Code® has accepted AC and MC cables for decades, with statistics showing that they have an excellent fire safety record.

Because AC & MC cable can be fished for long distances, it is quick and easy to install. Its own weight can carry it between partitions and it can be run without concern for its contact with pipes or other obstructions.

Wire pullers, fish ropes or tapes, dispensers and lubricants are eliminated. AC & MC cable does the job in less space, with fewer bending restrictions as well as less cutting and connecting than most other wiring products.

Armored cable (Type AC) and Metal Clad cable (Type MC) have a flexible metal armor of similar outward appearance, but that is where the similarity ends. There are major differences in construction and uses permitted.

Armored (Type AC) Cable Construction

As described by the National Electrical Code® Article 320, armored cable Type AC is a “fabricated assembly of insulated conductors in a flexible metallic enclosure.”

Type AC cable is manufactured to UL Standard 4. It consists of 2 to 4 copper conductors in sizes 14 AWG to 1 AWG inside an interlocked metal armor of steel or aluminum construction. Type AC cable can have no more than four insulated conductors plus a grounding conductor (for a total of 5 conductors only) and cannot be manufactured larger than 1 AWG per UL 4.

A 16 AWG aluminum bonding wire is inside of, and in physical contact with, the metal armor providing a low-impedance fault-return path required for the operation of overcurrent protection devices. The bonding wire is unique to AC cable and allows the outer metal armor in conjunction with the bonding wire to be used as an equipment ground.

It is important to remember that the bare bond wire is not an equipment grounding conductor. It is the bond wire that, in combination with the interlocked metal armor, provides a low impedance equipment grounding path.

Each of the copper conductors is covered with a thermoplastic insulation (THHN with a 90°C rating) and are individually wrapped in a moisture resistant, fire retardant paper.

According to NEC® Article 320.40, an insulated (anti-short) bushing is required when installing Type AC cable. It is installed at the time of termination and designed to protect the conductors from damage. AFC provides bushings in bags packaged with the cable.

Metal Clad (Type MC) Cable Construction

As described by NEC® Article 330, Metal Clad Type MC cable is a “factory assembly of one or more insulated circuit conductors with or without optical fiber members enclosed in an armor of interlocking metal tape or a smooth or corrugated metallic sheath.”

Traditional Type MC cable is manufactured to UL Standard 1569. MC cables have 2 or more solid or stranded conductors in sizes 18 AWG and larger. The number of conductors allowed in an MC cable is not restricted by UL. The conductors may be of copper, aluminum or copper-clad aluminum.

The metal armor may be a smooth tube, a corrugated tube, or an interlocked metal armor. AFC Cable Systems manufactures MC cable with interlocked metal armor and copper conductors. The make-up of AFC Cable Systems’ 600 volt interlocked armor traditional MC cable consists of:

- Copper circuit and grounding conductors covered with thermoplastic insulation
- An overall polypropylene cable assembly tape
- An outer galvanized steel or aluminum interlocked armor

Unlike Type AC cable, the armor of interlocked Type MC cable is not an equipment grounding means and traditional Type MC cable requires a bare or green grounding conductor.

Differences between AC and traditional MC cables.

	TYPE AC CABLE	TYPE MC CABLE
NUMBER OF CONDUCTORS	Limited to a maximum of 4 conductors plus a grounding conductor.	Not limited to the number of conductors.
SIZE OF CONDUCTORS	14 AWG to 1 AWG	18 AWG or larger
GROUNDING	Contains a 16 AWG bond wire in constant contact with the metal armor allowing the armor and bond wire combination to be used as an equipment ground.	Does not contain a bonding wire and the armor is not an equipment ground, but supplements the internal grounding conductor equaling one grounding path.
CONDUCTOR WRAPPING	Individual conductors are wrapped in a moisture resistant, fire retardant paper.	Individual conductors are not wrapped in fire Retardant paper but do have an overall polypropylene assembly tape.

Along with these differences in construction, there are also differences in the uses permitted for these cables as discussed previously. (See pages 14 and 15 for installation details on new MCI-A type MC cables.)

Green Hospital Grade Type Cable

This additional ground allows HCF cables to be used in patient care areas of health care facilities (other than hazardous locations) including hospitals, nursing homes, dental offices, outpatient facilities and medical centers per NEC® 517.13.

The separate green grounding conductor satisfies the requirement of Article 517 that:

“In an area used for patient care, the grounding terminals of all receptacles and all non-current-carrying conductive surfaces of fixed electric equipment likely to become energized that are subject to personal contact, operating at over 100 volts, shall be grounded by an insulated copper conductor.”

The armor and bonding strip combination satisfies the requirement that:

“...all branch circuits serving patient care areas shall be provided with a ground path for fault current by installation in a metal raceway system or cable assembly. The metal raceway system, or cable armor or sheath assembly, shall itself qualify as an equipment grounding return path in accordance with Section 250.118.”

(NOTE: Read NEC 517.30(C)(3)(3) for complete details on wiring of emergency healthcare circuits.)

Installing AC & MC Cable

Type AC & MC cable is installed after the rough-in phase of locating and setting all boxes and enclosures. Rough-in occurs when all the interior and exterior walls are framed but before the sheet rock is installed.

The first step in the rough-in phase is to determine the number of home run circuits and from where the wiring will originate. Once this is done, time should be taken to determine the best and shortest routes for each cable run. Long runs of spider web type routing not only require more cable, but also increase voltage drop. This is very important to consider when locating boxes for receptacles, lights and switches. If long runs are required, oversizing the circuit conductors is recommended to limit voltage drop.

MC or AC Cable Installation

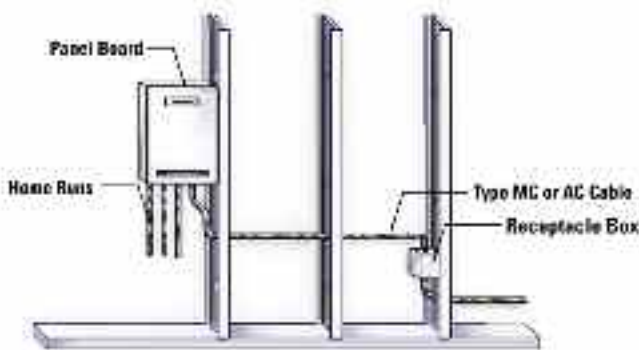

AC & MC cable is available on reels and in coils. If using a reel, simply draw the cable from the end of the reel. If using a coil, draw the cable from the center of the coil to prevent kinking.



A coil of MC cable

Bridging Cable Across Open Spaces

In general, AC and MC cable must hug the surface it is wired over. The NEC prohibits bridging across open spaces with the following five exceptions:

- 1) When the cable is fished.
- 2) When flexibility is required, a box may be installed near a motor or appliance using a short piece of free AC cable up to 24 inches long, between the box and motor or appliance.
- 3) Lengths of not more than 6 feet from the last point of support for connections within an accessible ceiling to lighting fixtures or equipment.
- 4) Where installed in cable trays.
- 5a) For **Type AC** cable in other than vertical runs through holes or notches in framing members where distance between members does not exceed 4½ feet and is securely fastened in place by an approved means within 12 inches of each box, cabinet, conduit body or other cable termination.
- 5b) For **Type MC** cable in other than vertical runs through holes or notches in framing members where the distance between members does not exceed 6 feet. Cables containing four or fewer conductors sized no larger than AWG 10 must be secured within 12 inches of each box, cabinet, fitting or other cable termination.

Bending Radius

Care should be taken not to exceed the bending radius of the cables when routing around corners. According to NEC Article 320.24, for AC cable, the radius of the curve of the inner edge of any bend shall not be less than 5 times the diameter of the cable. NEC Article 330.24(B) states that for MC Cable, the radius shall not be less than 7 times the external diameter of the cable.

Terminating AC & traditional MC Cables

When terminating or splicing at a junction, outlet or switch box, cut the cable so that 6 inches of free conductor is left for connections or splices.

Use an approved connector and insure a proper bond by firmly tightening the connectors to both the box and the cable.

Please note: set screw connectors cannot be used with aluminum armor Type AC cable. To terminate an AC cable, insert an anti-short bushing and bend back the exposed length of bonding wire. The bonding wire can be bent back before or after the bushing is inserted. There are several techniques used for this procedure as pictured on the next page.



Supporting AC & MC Cables

All cable runs must be continuous from outlet to outlet. According to NEC® Article 320.30, AC cable must be supported and secured at intervals of 4½ feet or less (unless routed through a framing member) and within 12 inches of every termination.

Supporting Type AC Cable

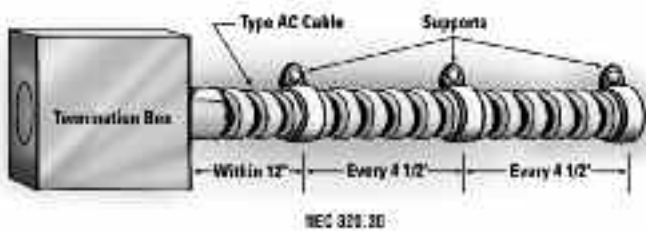

According to NEC Article 330.30, MC cable must be supported and secured at intervals of 6 feet or less (unless routed through a framing member) and cables containing four or fewer conductors sized no larger than 10 AWG must be secured within 12 inches of every termination.

Supporting Type MC Cable



As noted, AC and MC cable support requirements are waived when the cable is fished. This is a major advantage of AC and MC cable in remodeling work over other wiring products that cannot be fished.

AC and MC cable may also be installed in cable tray, per NEC Article 392. Cable is only required to be secured in this installation for vertical runs.

Terminating AC & traditional MC Cables

When terminating or splicing at a junction, outlet or switch box, cut the cable so that 6 inches of free conductor is left for connections or splices. Use an approved connector and insure a proper bond by firmly tightening the connectors to both the box and the cable.

Please note, set screw connectors cannot be used with aluminum armor Type AC cable.

To terminate an AC cable, insert an anti-short bushing and bend back the exposed length of bonding wire.

The bonding wire can be bent back before or after the bushing is inserted. There are several techniques used for this procedure as pictured on this page.

Insert the cable into the connector and secure the connector into the box. Be sure that the anti-short bushing is plainly visible in the connector for easy inspection. The same procedure is followed for traditional MC cable with the exception that there is no bonding wire. Although anti-short bushings are only required by the NEC® for AC cable, some manufacturers supply them for both cable types in the event that local codes override the NEC®.



Preparing AC Cable for Termination

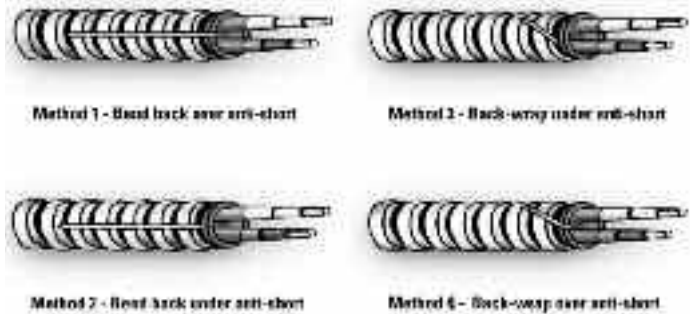

(Bond wire may also be cut off at the end of the armor)

Terminating AC & traditional MC Cables

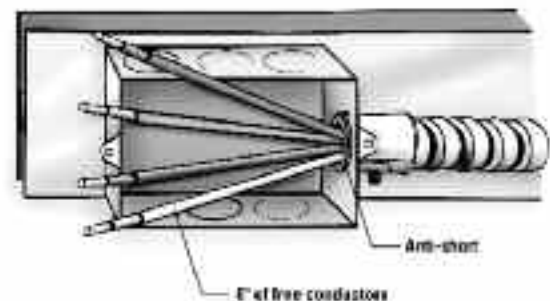

MC cable installed in a box with 6 inches of free conductors left for connections or splices.

MC & AC Connector Cross-Reference Guide

MC TUFF®, MC Lite®, MC Steel Lightweight (MC) Steel Armor

Trade Size	Armor Mi. O.D. (in.)	AFC	Bridgeport	OZ-Gedney	Arlington	Raco
14-2	0.470	AFC-50, 52	570-DC, 570-MC	PK-75	4010AST	3202
14-3	0.480	AFC-50, 52	570-DC, 570-MC	PK-75	4010AST	3202
14-4	0.510	AFC-50, 52	570-DC, 570-MC	PK-75	4010AST	3202
12-2	0.495	AFC-50, 52	570-DC, 570-MC	PK-75	4010AST	3202
12-3	0.530	AFC-50, 52	570-DC, 570-MC	PK-75	4010AST	3202
12-4	0.565	AFC-50	570-DC, 570-MC	PK-75	4010AST	3202
10-2	0.560	AFC-50	570-DC, 570-MC	PK-75	4010AST	3202
10-3	0.600	AFC-50, 5075	575-MC	PK-75	4010AST	3202
10-4	0.645	AFC-75, 5075	575-MC	PK-751	45AST	—
8-2	0.651	AFC-75, 5075	561-DC2	PK-751	45AST	—
8-3	0.704	AFC-75, 5075	561-DC2	PK-751	45AST	—
8-4	0.852	AFC-75, 5075	561-DC2	PK-101	8412	—
6-2	0.795	AFC-75	561-DC2	PK-101	8412	—
6-3	0.855	AFC-75	561-DC2	PK-101	8412	—
6-4	0.945	—	683-DC2	PK-125	—	—
4-2	0.945	—	683-DC2	PK-125	—	—
4-3	1.035	—	683-DC2	PK-125	—	—
4-4	1.135	—	684-DC2	PK-125	—	—
2-2	1.075	—	684-DC2	PK-125	—	—
2-3	1.180	—	684-DC2	PK-125	—	—
2-4	1.295	—	685-DC2	PK-125	—	—
1-3	1.185	—	684-DC2	PK-125	—	—
1-4	1.325	—	685-DC2	PK-150	—	—
1/0-3	1.255	—	685-DC2	PK-125	—	—
1/0-4	1.390	—	685-DC2	PK-150	—	—
2/0-3	1.350	—	685-DC2	PK-150	—	—
2/0-4	1.520	—	685-DC2	PK-200	—	—
3/0-3	1.520	—	685-DC2	PK-200	—	—
3/0-4	1.690	—	—	PK-200	—	—
4/0-3	1.580	—	—	PK-200	—	—
4/0-4	1.770	—	686-DC2	PK-200	—	—

SUPER NEUTRAL CABLE® (MC) Steel or Aluminum Armor

Product Code	Phase Conductors Size/No.	Neutral Conductors Size/No.	Ground Conductors Size/No.	Armor Mi. O.D. (in.)	AFC	OZ-Gedney	Arlington
2916	12-2	12-2	12-2	0.580	AFC-75	PK-75	4010AST
2911	12-3	12-3	12-2	0.620	AFC-75	PK-751	4010AST
2960	12-4	12-3	12-2	0.659	AFC-75	PK-751	4010AST
2965	10-2	10-2	10-2	0.670	AFC-75	PK-751	45AST
2912	10-3	10-3	10-2	0.720	AFC-75, 5075	PK-751	45AST
Oversize Neutral Design							
2908	12-1	10-1	12-1	0.510	AFC-50	PK-75	380AST
2909	12-2	10-1	12-1	0.540	AFC-50	PK-75	380AST
2910	12-3	10-1	12-1	0.580	AFC-75	PK-75	380AST
2907	12-3	10-1	12-2	0.590	AFC-75	PK-75	380AST
2905	12-3	8-1	12-1	0.595	AFC-75	PK-75	45AST
2920	12-4	10-2	12-1	0.640	AFC-75	PK-751	45AST
2918	12-4	10-2	12-2	0.660	AFC-75	PK-751	45AST
2913	10-3	6-1	10-1	0.720	AFC-75, 5075	PK-751	45AST
2970	10-4	8-2	10-2	0.800	AFC-75	PK-101	45AST

PARKING DECK/LOT CABLE™ Jacketed Metal Clad Cable (MC) (Non-Hazardous Locations)

Trade Size	Mi. O.D. (in.) Armor	Jacket	AFC*	AFC Connector**	Appleton	Bridgeport	Killark**	OZ-Gedney
12-2	0.495	0.605	AFC-50	AFC595**	TMC050A	895-DC2	MCRA-050	PG-66-05A
12-3	0.530	0.640	AFC-50	AFC595**	TMC050A	895-DC2	MCRA-050	PG-66-05A
12-4	0.565	0.675	AFC-50	AFC595**	TMC050A	895-DC2	MCRA-050	PG-78-05A
10-2	0.560	0.670	AFC-50	AFC595**	TMC050A	895-DC2	MCRA-050	PG-78-05A
10-3	0.600	0.710	AFC-75, 5075	AFC595**	TMC050A	895-DC2	MCRA-050	PG-78-05A
10-4	0.645	0.755	AFC-75, 5075	—	TMC050A	—	MCRA-050	PG-78-05A
8-2	0.651	0.945	AFC-75, 5075	—	TMC050A	—	MCRA-050	PG-78-05A
8-3	0.704	0.795	AFC-75, 5075	—	TMC050LA	—	MCRA-075	PG-89-05A
8-4	0.852	0.945	AFC-75	—	TMC050LA	—	MCRA-075	PG-98-05A
6-2	0.795	0.905	AFC-75	—	TMC050LA	—	MCRA-075	PG-98-05A
6-3	0.855	0.965	—	—	TMC050LA	—	MCRA-075	PG-98-05A
6-4	0.945	1.055	—	—	TMC075LA	—	MCRA-100	PG-121-07A
4-3	1.035	1.145	—	—	TMC075LA	—	MCRA-100	PG-107-10A
4-4	1.135	1.245	—	—	TMC100A	—	MCRA-100	PG-138-10A
2-3	1.180	1.290	—	—	TMC100A	—	MCRA-125	PG-138-10A
2-4	1.295	1.405	—	—	TMC125A	—	MCRA-125	PG-163-12A
1-3	1.185	1.295	—	—	TMC100A	—	MCRA-125	PG-138-12A
1-4	1.325	1.435	—	—	TMC125A	—	MCRA-125	PG-163-12A
1/0-3	1.255	1.365	—	—	TMC100A	—	MCRA-125	PG-163-12A

The connector cross-reference guide is provided as a service to our customers. It is not intended to be a manufacturer's recommendation, or an all inclusive listing. The information contained herein is based on manufacturers' published literature. Consult appropriate manufacturer for more information.

MC & AC Connector Cross-Reference Guide (Continued)

HOME RUN CABLE® Home Run Cable® (MC) Steel or Aluminum Armor

Trade Size	Armor Mi. O.D. (in.)	AFC	Bridgeport	OZ-Gedney	Arlington
12-6	0.580	AFC-75	560-DC2	PK-75	380AST
12-8	0.660	AFC-75	561-DC2	PK-751	45AST
12-12	0.755	—	561-DC2	PK-751	45AST
12-16	0.830	—	561-DC2	PK-101	45AST
10-6	0.670	—	561-DC2	PK-751	45AST
10-8	0.765	—	561-DC2	PK-751	45AST
10-12	0.890	—	683-DC2	PK-101	50AST
10-16	0.980	—	683-DC2	PK-101	L18

FIRE ALARM® Control Cable (MC)

Trade Size	Armor Mi. O.D. (in.)	AFC	Bridgeport	OZ-Gedney	Arlington
18-2	0.410	—	570-RI	—	38AST
18-4	0.430	—	570-RI	PK-75	38AST
18-6	0.490	AFC-50	570-RI	PK-75	38AST
18-8	0.510	AFC-50	570-RI	PK-75	38AST
16-2	0.420	AFC-50	570-RI	PK-75	38AST
16-4	0.440	AFC-50	570-RI	PK-75	38AST
16-6	0.510	AFC-50	570-RI	PK-75	38AST
16-8	0.520	AFC-50	570-RI	PK-75	38AST
14-2	0.470	AFC-50	570-RI	PK-75	38AST
14-4	0.510	AFC-50	570-RI	PK-75	38AST
14-6	0.520	AFC-50	570-RI	PK-75	38AST
14-8	0.585	AFC-75	570-RI	PK-75	38AST
12-2	0.495	AFC-50	570-RI	PK-75	38AST
12-4	0.565	AFC-50	570-RI	PK-75	38AST
18-2*	0.420	AFC-50	570-RI	PK-75	38AST
16-2*	0.430	AFC-50	570-RI	PK-75	38AST
16-4**	0.450	AFC-50	570-RI	PK-75	38AST
14-2*	0.470	AFC-50	570-RI	PK-75	38AST
18-2†14-2**	0.640	AFC-75	561-DC2	PK-751	45AST

AC Armored Cable (AC) Steel or Aluminum Armor

Trade Size	Armor Mi. O.D. (in.)	AFC	Appleton	Bridgeport	Neer	OZ-Gedney	Arlington	T&B
14-2	0.433	AFC-50, 52	7315V	565-DC2	C-510, TA-38	C-1Z†, C-15L	38AST	300TB
14-3	0.453	AFC-50, 52	7315V	565-DC2	C-510, TA-38	C-1Z†, C-15L	38AST	300TB
14-4	0.486	—	7315V	565-DC2	C-510, TA-38	C-1Z†, C-15L	38AST	300TB
12-2	0.467	AFC-50, 52	7315V	565-DC2	C-510, TA-38	C-1Z†, C-15L	38AST	300TB
12-3	0.489	AFC-50, 52	7315V	565-DC2	C-510, TA-38	C-1Z†, C-15L	38AST	300TB
12-4	0.520	AFC-50, 52	7315V	565-DC2	C-510, TA-38	C-1Z†, C-15L	38AST	300TB
10-2	0.476	AFC-50, 52	7315V	565-DC2	C-510, TA-38	C-1Z†, C-15L	38AST	300TB
10-3	0.500	AFC-50	7315V	565-DC2	C-510, TA-38	C-1Z†, C-15L	38AST	300TB
10-4	0.541	AFC-75, 5075	7315V	635-DC2	C-510, TA-38	C-1Z†, C-15L	38AST	300TB
8-2*	0.604	AFC-75	7315V	635-DC2	—	C-1Z†, C-15L	38AST	300TB
8-3*	0.637	AFC-75, 5075	7287V	635-DC2	—	KC-50	45AST	300TB
8-4*	0.695	AFC-75, 5075	7287V	653-DC2	—	KC-50	45AST	—
6-2*	0.700	AFC-75	7287V	653-DC2	—	KC-50	45AST	—
6-3*	0.739	AFC-75, 5075	7287V	653-DC2	—	KC-50	45AST	302
6-4*	0.807	—	7287V	653-DC2	—	KC-50	45AST	302
4-2*	0.836	—	7287V	653-DC2	—	KC-50	45AST	302
4-3*	0.885	—	7287V	653-DC2	—	KC-50	5090AST	302
4-4*	0.970	—	7289V	—	—	KC-75	L18	304
2-3*	1.014	—	7289V	—	—	KC-75	L18	304
2-4*	1.115	—	7289V	—	—	KC-100	L19	—

HCF Health Care Facilities Cable (AC) Steel or Aluminum Armor

Trade Size	Armor Mi. O.D. (in.)	AFC	Appleton	Bridgeport	Neer	OZ-Gedney	Arlington
14-2	0.453	AFC-50, 52	7315V	570-GI	C-510, TA-38	C-1Z†	MC38DC
14-3	0.486	AFC-50, 52	7315V	570-GI	C-510, TA-38	C-1Z†	MC38DC
14-4	0.522	—	7315V	570-GI	C-510, TA-38	C-1Z†	MC38DC
12-2	0.489	AFC-50, 52	7315V	570-GI	C-510, TA-38	C-1Z†	MC38DC
12-3	0.520	AFC-50, 52	7315V	570-GI	C-510, TA-38	C-1Z†	MC38DC
12-4	0.545	AFC-50	7315V	570-GI	C-510, TA-38	C-1Z†	MC38DC
10-2	0.500	AFC-50, 52	7315V	570-GI	C-510, TA-38	C-1Z†	MC38DC
10-3	0.541	AFC-50, 52	7315V	570-GI	C-510, TA-38	C-1Z†	MC38DC
10-4	0.587	AFC-75, 5075	7315V	570-GI	—	C-1Z†	MC38DC

† Steel Armor only

* One twisted shielded pair

** Two twisted shielded pairs

The connector cross-reference guide is provided as a service to our customers. It is not intended to be a manufacturer's recommendation, or an all inclusive listing. The information contained herein is based on manufacturers' published literature. Consult appropriate manufacturer for more information.

MCI-A Connector Cross-Reference Guide

MC-Quik® Steel MCI-A Cable

Trade Size	Overall Nom. O.D. (in)	Manufacturers	MODEL #										
			AFC-50	AFC-52									
14-2	0.422	AFC Cable Systems	AFC-50	AFC-52									
		Bridgeport	380SP	3838ASP	3838SP	38ASP	545-DC2	560-DC2	560-DCI2	560-MCIA2	565-DC2	566-DC2	570-DC2
			3838ASP	38ASP	560-DC2	560-MCIA2	566-DC2	570-DCI2	590-DC2	601-DC2	802MCIA	8400SP	845ASP
			3838SP	545-DC2	560-DCI2	565-DC2	570-DC2	570-DCR2	590-DCI2	802-DC2	8400MCIA	840SP	845SP
14-3	0.467	AFC Cable Systems	AFC-50	AFC-52									
		Bridgeport	380SP	3838ASP	3838SP	38ASP	545-DC2	560-DC2	560-DCI2	560-MCIA2	565-DC2	566-DC2	570-DC2
			3838ASP	38ASP	560-DC2	560-MCIA2	566-DC2	570-DCI2	590-DC2	601-DC2	802MCIA	8400SP	845ASP
			3838SP	545-DC2	560-DCI2	565-DC2	570-DC2	570-DCR2	590-DCI2	802-DC2	8400MCIA	840SP	845SP
14-4	0.503	AFC Cable Systems	AFC-50	AFC-52									
		Bridgeport	380SP	3838ASP	3838SP	38ASP	545-DC2	560-DC2	560-DCI2	560-MCIA2	565-DC2	566-DC2	570-DC2
			3838ASP	38ASP	560-DC2	560-MCIA2	566-DC2	570-DCI2	590-DC2	601-DC2	802MCIA	8400SP	845ASP
			3838SP	545-DC2	560-DCI2	565-DC2	570-DC2	570-DCR2	590-DCI2	802-DC2	8400MCIA	840SP	845SP
12-2	0.463	AFC Cable Systems	AFC-50	AFC-52									
		Bridgeport	380SP	3838ASP	3838SP	38ASP	545-DC2	560-DC2	560-DCI2	560-MCIA2	565-DC2	566-DC2	570-DC2
			3838ASP	38ASP	560-DC2	560-MCIA2	566-DC2	570-DCI2	590-DC2	601-DC2	802MCIA	8400SP	845ASP
			3838SP	545-DC2	560-DCI2	565-DC2	570-DC2	570-DCR2	590-DCI2	802-DC2	8400MCIA	840SP	845SP
12-3	0.523	AFC Cable Systems	AFC-50	AFC-52									
		Bridgeport	380SP	3838ASP	3838SP	38ASP	545-DC2	560-DC2	560-DCI2	560-MCIA2	565-DC2	566-DC2	570-DC2
			3838ASP	38ASP	560-DC2	560-MCIA2	566-DC2	570-DCI2	590-DC2	601-DC2	802MCIA	8400SP	845ASP
			3838SP	545-DC2	560-DCI2	565-DC2	570-DC2	570-DCR2	590-DCI2	802-DC2	8400MCIA	840SP	845SP
12-4	0.565	AFC Cable Systems	AFC-50	AFC-52									
		Bridgeport	380SP	3838ASP	SG38MCIA	845ASP	AMC-50MCIA	BL16ASP	545-DC2	560-DCI2	570-DC2	570-DCR2	590-DCI2
			38ASP	SG38SP	8400MCIA	846SP	AMC-52	BL16MCIA	560-DC2	560-MCIA2	570-DCI2	590-DC2	601-DC2
			3838SP	SG38ASP	845SP	AMC-50	BL16SP						
10-2	0.525	AFC Cable Systems	AFC-50	AFC-52									
		Bridgeport	380SP	3838ASP	3838SP	38ASP	545-DC2	560-DC2	560-DCI2	560-MCIA2	565-DC2	566-DC2	570-DC2
			3838ASP	38ASP	560-DC2	560-MCIA2	566-DC2	570-DCI2	590-DC2	601-DC2	802MCIA	8400SP	845ASP
			3838SP	545-DC2	560-DCI2	565-DC2	570-DC2	570-DCR2	590-DCI2	802-DC2	8400MCIA	840SP	845SP
10-3	0.6	AFC Cable Systems	AFC-75	AFC-5075									
		Bridgeport	380SP	3838ASP	SG38MCIA	845ASP	AMC-50MCIA	BL16ASP	545-DC2	560-DCI2	570-DC2	570-DCR2	590-DCI2
			38ASP	SG38SP	8400MCIA	846SP	AMC-52	BL16MCIA	560-DC2	560-MCIA2	570-DCI2	590-DC2	601-DC2
			3838SP	SG38ASP	845SP	AMC-50	BL16SP						
10-4	0.651	AFC Cable Systems	AFC-75	AFC-5075									
12-2*	0.482	AFC Cable Systems	AFC-50	AFC-52									
		Bridgeport	380SP	3838ASP	3838SP	38ASP	545-DC2	560-DC2	560-DCI2	560-MCIA2	565-DC2	566-DC2	570-DC2
			3838ASP	38ASP	560-DC2	560-MCIA2	566-DC2	570-DCI2	590-DC2	601-DC2	802MCIA	8400SP	845ASP
			3838SP	545-DC2	560-DCI2	565-DC2	570-DC2	570-DCR2	590-DCI2	802-DC2	8400MCIA	840SP	845SP
12-3*	0.539	AFC Cable Systems	AFC-50	AFC-52									
		Bridgeport	380SP	3838ASP	SG38MCIA	845SP	AMC-50	BL16SP	545-DC2	560-MCIA2	570-DCI2	590-DC2	601-DC2
			38ASP	SG38SP	802MCIA	845ASP	AMC-50MCIA	BL16ASP	560-DC2	570-DC2	570-DCR2	590-DCI2	802-DC2
			3838SP	SG38ASP	8400MCIA	846SP	AMC-52	BL16MCIA	560-DCI2				
12-4*	0.585	AFC Cable Systems	AFC-75	AFC-5075									
		Bridgeport	380SP	3838ASP	SG38MCIA	845ASP	AMC-50MCIA	BL16ASP	545-DC2	560-DCI2	570-DC2	570-DCR2	590-DCI2
			38ASP	SG38SP	8400MCIA	846SP	AMC-52	BL16MCIA	560-DC2	560-MCIA2	570-DCI2	590-DC2	601-DC2
			3838SP	SG38ASP	845SP	AMC-50	BL16SP						

* Stranded copper conductors

MCI-A Connector Cross-Reference Guide (Continued)

MC-Stat® Steel MCI-A Cable

Trade Size	Overall Nom. O.D. (in)	Manufacturers	MODEL #										
12-2	0.523	AFC Cable Systems	AFC-50	AFC-52									
		Bridgeport	380SP	3838ASP	SG38MCIA	8400SP	845ASP	AMC-50MCIA	BL16ASP	560-DC2	565-DC2	570-DCI2	590-DCI2
			38ASP	SG38SP	802MCIA	8400MCIA	846SP	AMC-52	BL16MCIA	560-DCI2	566-DC2	570-DCR2	601-DC2
			3838SP	SG38ASP	840SP	845SP	AMC-50	BL16SP	545-DC2	560-MCIA2	570-DC2	590-DC2	802-DC2
12-3	0.565	AFC Cable Systems	AFC-50	AFC-52									
		Bridgeport	380SP	3838ASP	SG38MCIA	845ASP	AMC-50MCIA	BL16ASP	560-DC2	570-DC2	570-DCR2	590-DCI2	560-MCIA2
			38ASP	SG38SP	8400MCIA	846SP	AMC-52	BL16MCIA	560-DCI2	570-DCI2	590-DC2	601-DC2	545-DC2
			3838SP	SG38ASP	845SP	AMC-50	BL16SP						
12-4	0.618	AFC Cable Systems	AFC-75	AFC-5075									
10-2	0.6	AFC Cable Systems	AFC-75	AFC-5075									
		Bridgeport	380SP	3838SP	SG38SP	SG38MCIA	845SP	846SP	AMC-50MCIA	BL16SP	BL16MCIA	560-DC2	560-MCIA2
			38ASP	3838ASP	SG38ASP	8400MCIA	845ASP	AMC-50	AMC-52	BL16ASP	545-DC2	560-DCI2	570-DC2
			570-DCI2	570-DCR2	590-DC2	590-DCI2	601-DC2						
10-3	0.651	AFC Cable Systems	AFC-75	AFC-5075									
10-4	0.786	AFC Cable Systems	AFC-75	AFC-5075									
12-2 *	0.539	AFC Cable Systems	AFC-50	AFC-52									
		Bridgeport	380SP	3838ASP	SG38MCIA	845SP	AMC-50	BL16SP	545-DC2	560-MCIA2	570-DCR2	590-DCI2	601-DC2
			38ASP	SG38SP	802MCIA	845ASP	AMC-50MCIA	BL16ASP	560-DC2	570-DC2	590-DC2	570-DCI2	802-DC2
			3838SP	SG38ASP	8400MCIA	846SP	AMC-52	BL16MCIA	560-DCI2				
12-3 *	0.585	AFC Cable Systems	AFC-75	AFC-5075									
		Bridgeport	380SP	3838ASP	SG38MCIA	845ASP	AMC-50MCIA	BL16ASP	560-DC2	570-DC2	590-DC2	560-MCIA2	570-DCR2
			38ASP	SG38SP	8400MCIA	846SP	AMC-52	BL16MCIA	560-DCI2	570-DCI2	590-DCI2	545-DC2	601-DC2
			3838SP	SG38ASP	845SP	AMC-50	BL16SP						

* Stranded copper conductors

MCI-A Connector Cross-Reference Guide (Continued)

MC-Quik® Lite Aluminum MCI-A Cable (continued)

Trade Size	Overall Nom. O.D. (in)	Manufacturers	MODEL #													
			AFC Cable Systems	AFC-50	AFC-52											
10-2	0.525	AFC Cable Systems	AFC-50	AFC-52												
		Bridgeport	380SP	38ASP	3838SP	3838ASP	SG38SP	SG38ASP	SG38MCIA	802MCIA	840SP	8400SP	8400MCIA	845SP	845ASP	846SP
			AMC-50	AMC-50MCIA	AMC-52	BL16SP	BL16ASP	BL16MCIA	545-DC2	560-DC2	560-DCI2	560-MCIA2	565-DC2	566-DC2	570-DC2	570-DCI2
			570-DCR2	590-DC2	590-DCI2	601-DC2	802-DC2									
		Arlington	84690ST	850	850A	84690	840	8400	L160ST	SG3838	SG3838A	SG3838AST	SG3838ST	846	SG38	SG38A
			404010AST	SG380	SG380AST	SG38ST	4010AST	SG380A	SG380AST	8400ST	840ST	846ST	L160	L160AST		
		Crouse-Hinds	707	1707	723	1723	724	699	702V	700	ACB38	ACB3845	ACB3890	ACB50	ACB5090	SSACB38
			SSACB50	QLD60S	QLK50D											
		Steel Components	MSC38	MSC3890	MSC3890D	BX38	BX38D	QL-50	QL-50D	DB38	DB3845	DB3890	DB50	DB5045	DB5090	SSC50DB50
			MSC3845													
		Madison Electric	ML-42	IML-42	ML-110	IML-110	MAFC-50	MAFC-52	MDB-38B	MDB-50B						
		Thomas & Betts	300	3110	3130	321	XC-730	XC-731	XC-7300	XC-2200C						
		Raco	2700AJ	2101	2201	2221	2715	2800	3201							
		NEER	TA-38	AC-90	ACI-90	DC-5500										
O-Z/Gedney	ACV-938	ACV-938T	25-38C													
Halex	85403NB	95403NB														
10-3	0.6	AFC Cable Systems	AFC-75	AFC-5075												
		Bridgeport	380SP	38ASP	3838SP	3838ASP	SG38SP	SG38ASP	SG38MCIA	8400MCIA	845SP	845ASP	846SP	AMC-50	AMC-50MCIA	AMC-52
			BL16SP	BL16ASP	BL16MCIA	545-DC2	560-DC2	560-DCI2	560-MCIA2	570-DC2	570-DCI2	570-DCR2	590-DC2	590-DCI2	601-DC2	
			84690ST	850	850A	84690	SG3838	SG3838A	SG3838AST	SG3838ST	846	846ST				
		Arlington	84690ST	850	850A	84690	SG3838	SG3838A	SG3838AST	SG3838ST	846	846ST				
			404010AST	SG380	SG380AST	SG38ST	4010AST	SG380A	SG380AST	8400ST	840ST	846ST	L160	L160AST		
		Crouse-Hinds	723	1723	724	ACB38	ACB50	ACB5090	SSACB38	SSACB50						
			SSACB50	QLD60S	QLK50D											
		Steel Components	QL-50	DB50	DB5045	DB5090	SSC50DB50									
			MSC38	MSC3890	MSC3890D	BX38	BX38D	QL-50	QL-50D	DB38	DB3845	DB3890	DB50	DB5045	DB5090	SSC50DB50
		Thomas & Betts	300	3110	3130	321	XC-731									
		Madison Electric	ML-110	IML-110	MAFC-50	MDB-50B										
		Raco	2201	2221	3201											
		NEER	AC-90	ACI-90	DC-5500											
O-Z/Gedney	ACV-938	ACV-938T														
Halex	95403NB															
10-4	0.651	AFC Cable Systems	AFC-75	AFC-5075												
		NEER	AC-90	ACI-90	DC-5500											
		Arlington	850	850A												
		O-Z/Gedney	ACV-938	ACV-938T												
		Crouse-Hinds	ACB38													
12-2 *	0.482	AFC Cable Systems	AFC-50	AFC-52												
		Bridgeport	380SP	38ASP	3838SP	3838ASP	SG38SP	SG38ASP	SG38MCIA	802MCIA	840SP	8400SP	8400MCIA	845SP	845ASP	846SP
			AMC-50	AMC-50MCIA	AMC-52	BL16SP	BL16ASP	BL16MCIA	545-DC2	560-DC2	560-DCI2	560-MCIA2	565-DC2	566-DC2	570-DC2	570-DCI2
			570-DCR2	590-DC2	590-DCI2	601-DC2	802-DC2									
		Arlington	85ST	85	850	850A	840	8400	L160ST	SG3838	SG3838A	SG3838AST	SG3838ST	846	SG38	SG38A
			383810AST	404010AST	SG380	SG380AST	SG38ST	3810AST	4010AST	SG380A	SG380AST	8400ST	840ST	846ST	L160	L160AST
		Crouse-Hinds	723	1723	699	702V	700	ACB38	ACB3845	ACB3890	SSACB38	SSACB50	QLD50S	QLK50D		
			SSACB50	QLD60S	QLK50D											
		Steel Components	MSC3845	MSC3890D	BX38	BX38D	QL-50D	DB38	DB3845	DB3890	SSC50DB38					
			MSC38	MSC3845	MSC3890	MSC3890D	BX38	BX38D	QL-50	QL-50D	DB38	DB3845	DB3890	DB50	DB5045	DB5090
		Thomas & Betts	300	3110	3130	321	XC-730	XC-731	XC-7300	-XC-2200C						
		Raco	2700AJ	2201	2221	2715	2800	3201								
		NEER	TA-38	AC-90	ACI-90	DC-5500										
		O-Z/Gedney	ACV-938	ACV-938T	25-38C											
Madison Electric	MAFC-52	MDB-38B														
Halex	85403NB	95403NB														
12-3 *	0.539	AFC Cable Systems	AFC-50	AFC-52												
		Bridgeport	380SP	38ASP	3838SP	3838ASP	SG38SP	SG38ASP	SG38MCIA	802MCIA	8400MCIA	845SP	845ASP	846SP	AMC-50	AMC-50MCIA
			AMC-52	BL16SP	BL16ASP	BL16MCIA	545-DC2	560-DC2	560-DCI2	560-MCIA2	570-DC2	570-DCI2	570-DCR2	590-DC2	590-DCI2	601-DC2
			802-DC2													
		Arlington	84690ST	850	850A	84690	840	8400	L160ST	SG3838	SG3838A	SG3838AST	SG3838ST	846	SG38	SG38A
			404010AST	SG380	SG380AST	SG38ST	4010AST	SG380A	SG380AST	8400ST	840ST	846ST	L160	L160AST		
		Crouse-Hinds	707	1707	723	1723	724	699	702V	700	ACB38	ACB3845	ACB3890	ACB50	ACB5090	SSACB38
			SSACB50	QLD60S	QLK50D											
		Steel Components	MSC38	MSC3845	MSC3890	MSC3890D	BX38	BX38D	QL-50	QL-50D	DB38	DB3845	DB3890	DB50	DB5045	DB5090
			SSC50DB50													
		Madison Electric	ML-42	IML-42	ML-110	IML-110	MAFC-50	MAFC-52	MDB-38B	MDB-50B						
		Raco	2700AJ	2101	2201	2221	2715	2800	3201							
		Thomas & Betts	300	3110	3130	321	XC-731	XC-2200C								
		NEER	TA-38	AC-90	ACI-90	DC-5500										
O-Z/Gedney	ACV-938	ACV-938T														
Halex	85403NB	95403NB														
12-4 *	0.585	AFC Cable Systems	AFC-75	AFC-5075												
		Bridgeport	380SP	38ASP	3838SP	3838ASP	SG38SP	SG38ASP	SG38MCIA	8400MCIA	845SP	845ASP	846SP	AMC-50	AMC-50MCIA	AMC-52
			BL16SP	BL16ASP	BL16MCIA	545-DC2	560-DC2	560-DCI2	560-MCIA2	570-DC2	570-DCI2	570-DCR2	590-DC2	590-DCI2	601-DC2	
			707	1707	723	1723	724	699	702V	700	ACB38	ACB3845	ACB3890	ACB50	ACB5090	SSACB38
		Crouse-Hinds	SSACB50	QLD60S	QLK50D											
			MSC38	MSC3845	MSC3890	MSC3890D	BX38	BX38D	QL-50	QL-50D	DB38	DB3845	DB3890	DB50	DB5045	DB5090
		Steel Components	SSC50DB50													
			MSC38	MSC3845	MSC3890	MSC3890D	BX38	BX38D	QL-50	QL-50D	DB38	DB3845	DB3890	DB50	DB5045	DB5090
		Arlington	84690ST	850	850A	84690	SG3838	SG3838A	SG3838AST	SG3838ST	846	846ST				
		Madison Electric	ML-42	IML-42	ML-110	IML-110	MAFC-50	MAFC-52	MDB-38B	MDB-50B						
		Raco	2101	2201	2221	2715	2800	3201								
		Thomas & Betts	300	3110	3130	321	XC-731									
		NEER	AC-90	ACI-90	DC-5500											
		O-Z/Gedney	ACV-938	ACV-938T												
Halex	95403NB															

* Stranded copper conductors

MCI-A Connector Cross-Reference Guide (Continued)

MC-Stat® Lite Aluminum MCI-A Cable

Trade Size	Overall Nom. O.D. (in)	Manufacturers	MODEL #													
12-2	0.523	AFC Cable Systems	AFC-50	AFC-52												
		Bridgeport	380SP	3838ASP	SG38MCIA	8400SP	845ASP	AMC-50MCIA	BL16ASP	560-DC2	565-DC2	570-DCI2	590-DCI2	802-DC2	590-DC2	570-DC2
			38ASP	SG38SP	802MCIA	8400MCIA	846SP	AMC-52	BL16MCIA	560-DCI2	566-DC2	570-DCR2	601-DC2	560-MCIA2	545-DC2	BL16SP
			3838SP	SG38ASP	840SP	845SP	AMC-50									
		Arlington	84690ST	850A	840	L160ST	SG3838A	SG3838ST	SG38	404010AST	SG380AST	4010AST	SG380AST	840ST	L160	L160AST
			850	84690	8400	SG3838	SG3838AST	846	SG38A	SG380	SG38ST	SG380A	8400ST	846ST		
		Crouse-Hinds	707	1707	723	1723	724	699	702V	700	ACB38	ACB3845	ACB3890	SSACB38	SSACB50	QLD50S
			QLK50D													
		Steel Components	MSC38	MSC3845	MSC3890	MSC3890D	BX38	BX38D	QL-50	QL-50D	DB38	DB3845	DB3890	DB50	DB5045	DB5090
			SSC50DB50													
		Thomas & Betts	300	3110	3130	321	XC-730	XC-731	XC-7300	XC-2200C						
		Madison Electric	ML-42	IML-42	ML-110	IML-110	MAFC-50	MAFC-52	MDB-38B	MDB-50B						
		Raco	2700AJ	2101	2201	2221	2715	2800	3201							
		NEER	TA-38	AC-90	ACI-90	DC-5500										
O-Z/Gedney	ACV-938	ACV-938T	25-38C													
Halex	85403NB	95403NB														
12-3	0.565	AFC Cable Systems	AFC-50	AFC-52												
		Bridgeport	380SP	3838ASP	SG38MCIA	845ASP	AMC-50MCIA	BL16ASP	560-DC2	570-DC2	590-DC2	601-DC2	570-DCR2	560-MCIA2	545-DC2	BL16SP
			38ASP	SG38SP	8400MCIA	846SP	AMC-52	BL16MCIA	560-DCI2	570-DCI2	590-DCI2	AMC-50	845SP	SG38ASP	3838SP	
		Arlington	84690ST	850A	840	SG3838	SG3838AST	846	SG38A	SG380	SG38ST	SG380A	8400ST	846ST	840ST	SG380AST
			850	84690	8400	SG3838A	SG3838ST	SG38	404010AST	SG380AST	4010AST					
		Steel Components	MSC38	MSC3845	MSC3890	MSC3890D	BX38	BX38D	QL-50	QL-50D	DB38	DB3845	DB3890	DB50	DB5045	DB5090
			SSC50DB50													
		Crouse-Hinds	707	1707	723	1723	724	699	702V	700	ACB38	ACB3845	ACB3890	SSACB38	SSACB50	QLD50S
			QLK50D													
		Thomas & Betts	300	3110	3130	321	XC-731	XC-2200C								
		Madison Electric	ML-42	IML-42	ML-110	IML-110	MAFC-50	MAFC-52	MDB-38B	MDB-50B						
		Raco	2101	2201	2221	2715	2800	3201								
		NEER	AC-90	ACI-90	DC-5500											
		O-Z/Gedney	ACV-938	ACV-938T												
Halex	85403NB	95403NB														
12-4	0.618	AFC Cable Systems	AFC-75	AFC-5075												
		Crouse-Hinds	723	1723	724	ACB38	SSACB38	SSACB50								
		Steel Components	DB50	DB5045	DB5090	SSC50DB50										
		Raco	2201	2221	3201											
		NEER	AC-90	ACI-90	DC-5500											
		Madison Electric	ML-110	IML-110	MDB-50B											
		O-Z/Gedney	ACV-938	ACV-938T												
		Arlington	850	850A												
10-2	0.6	AFC Cable Systems	AFC-75	AFC-5075												
		Bridgeport	380SP	38ASP	3838SP	3838ASP	SG38SP	SG38ASP	SG38MCIA	8400MCIA	845SP	845ASP	846SP	AMC-50	AMC-	AMC-52
			BL16SP	BL16ASP	BL16MCIA	545-DC2	560-DC2	560-DCI2	560-MCIA2	570-DC2	570-DCI2	570-DCR2	590-DC2	590-DCI2	601-DC2	
		Arlington	84690ST	850	850A	84690	SG3838	SG3838A	SG3838AST	SG3838ST	846	846ST				
		Crouse-Hinds	723	1723	724	ACB38	SSACB38	SSACB50								
		Steel Components	QL-50	DB50	DB5045	DB5090	SSC50DB50									
		Thomas & Betts	300	3110	3130	321	XC-731									
		Madison Electric	ML-110	IML-110	MAFC-50	MDB-50B										
		Raco	2201	2221	3201											
		NEER	AC-90	ACI-90	DC-5500											
		O-Z/Gedney	ACV-938	ACV-938T												
		Halex	95403NB													

MCI-A Connector Cross-Reference Guide (Continued)

MC-Stat® Lite Aluminum MCI-A Cable (Continued)

Trade Size	Overall Nom. O.D. (in)	Manufacturers	MODEL #													
10-3	0.651	AFC Cable Systems	AFC-75	AFC-5075												
		Arlington	850	850A												
		O-Z/Gedney	ACV-938	ACV-938T												
		NEER	AC-90	ACI-90												
		Crouse-Hinds	ACB38													
10-4	0.786	AFC Cable Systems	AFC-75	AFC-5075												
		Steel Components	DBC50	DBS50												
12-2 *	0.539	AFC Cable Systems	AFC-50	AFC-52												
		Bridgeport	380SP	3838ASP	SG38MCIA	845SP	AMC-50	BL16SP	545-DC2	560-MCIA2	570-DCR2	601-DC2	590-DCI2	570-DCI2	560-DCI2	BL16MCIA
			38ASP	SG38SP	802MCIA	845ASP	AMC-50MCIA	BL16ASP	560-DC2	570-DC2	590-DC2	802-DC2	AMC-52	846SP	8400MCIA	SG38ASP
			3838SP													
		Arlington	84690ST	850A	840	L160ST	SG3838A	SG3838ST	SG38	404010AST	SG380AST	4010AST	SG380AST	840ST	L160	L160AST
			850	84690	8400	SG3838	SG3838AST	846	SG38A	SG380	SG38ST	SG380A	8400ST	846ST		
		Crouse-Hinds	707	1707	723	1723	724	699	702V	700	ACB38	ACB3845	ACB3890	SSACB38	SSACB50	QLD50S
			QLK50D													
		Steel Components	MSC38	MSC3845	MSC3890	MSC3890D	BX38	BX38D	QL-50	QL-50D	DB38	DB3845	DB3890	DB50	DB5045	DB5090
			SSC50DB50													
		Madison Electric	ML-42	IML-42	ML-110	IML-110	MAFC-50	MAFC-52	MDB-38B	MDB-50B						
		Raco	2700AJ	2101	2201	2221	2715	2800	3201							
		Thomas & Betts	300	3110	3130	321	XC-731	XC-2200C								
		NEER	TA-38	AC-90	ACI-90	DC-5500										
		O-Z/Gedney	ACV-938	ACV-938T												
Halex	85403NB	95403NB														
12-3 *	0.585	AFC Cable Systems	AFC-75	AFC-5075												
		Bridgeport	380SP	3838SP	SG38SP	SG38MCIA	845SP	846SP	AMC-50MCIA	BL16SP	BL16MCIA	560-DC2	560-MCIA2	570-DCI2	590-DC2	601-DC2
			38ASP	3838ASP	SG38ASP	8400MCIA	845ASP	AMC-50	AMC-52	BL16ASP	545-DC2	560-DCI2	570-DC2	570-DCR2	590-DCI2	
		Crouse-Hinds	707	1707	723	1723	724	699	702V	700	ACB38	ACB3845	ACB3890	SSACB38	SSACB50	QLD50S
			QLK50D													
		Steel Components	MSC38	MSC3845	MSC3890	MSC3890D	BX38	BX38D	QL-50	QL-50D	DB38	DB3845	DB3890	DB50	DB5045	DB5090
			SSC50DB50													
		Arlington	84690ST	850	850A	84690	SG3838	SG3838A	SG3838AST	SG3838ST	846	846ST				
		Madison Electric	ML-42	IML-42	ML-110	IML-110	MAFC-50	MAFC-52	MDB-38B	MDB-50B						
		Raco	2101	2201	2221	2715	2800	3201								
		Thomas & Betts	300	3110	3130	321	XC-731									
		NEER	AC-90	ACI-90	DC-5500											
		O-Z/Gedney	ACV-938	ACV-938T												
Halex	95403NB															

* Stranded copper conductors

AFC Fittings is Your Best Connection

Since 1994 AFC Fittings

has been providing good old fashioned quality. From connectors for Type MC, AC and HCF cables, to flexible metal conduit and liquid-tight flexible conduits (metallic and non-metallic) or steel EMT, Set Screw and

Compression Fittings, AFC has just about any type of terminating means you require. Quality and Service are the hallmarks of doing business with AFC Fittings.

AFC Armored Cable and Flexible Metal Conduit Connectors

- AFC Steel Box Connectors are design coordinated with AC & MC Cable and Flex from AFC Cable Systems

AFC Parking Deck and Parking Lot Cable

- Reasonably priced connectors that are appropriate for use with PVC Jacket MC cable (Parking Deck/Lot Cable™)

AFC Malleable Liquidtight Insulated and Uninsulated Fittings

- Designed and engineered to ensure excellent performance thanks to its heavy-duty, impact resistant construction

AFC Non-Metallic Liquidtight Connectors

- Available in one-piece or traditional multi-piece configurations

AFC Snap-Lok Flexible Metal Conduit Connectors

- Quality spring steel construction for maximum reliability and vibration resistance making it ideal for machine-fed installations

AFC Steel Setscrew Connectors and Couplings

- Durable one-piece assembly available with or without insulated throats

AFC Steel Compression Connectors and Couplings

- Strong steel construction available with or without insulated throats

AFC Raintight Compression Fittings

- Inner sealing gland prevents moisture from entering the conduit



AFC Parking Deck/Lot Cable™ Connectors

(Connector not approved for use in direct burial applications)



Specification Description

Specification	PVC Jacketed Cable Connector
MC Cable Connector	Reasonably priced connectors that are appropriate for use with PVC Jacket MC cable (Parking Deck/Lot Cable™).
Fits cable sizes	1/2 to 8/3 cable
Max. Armor O.D. inch	☆ Fits sizes .610 - .720
Max. Armor with Jacket O.D. inch	☆☆ Fits sizes .685 - .792
Thread Type	Tapered Threads
Material	Zinc die cast with external knockout gasket

References & Ratings

- Tapered external NPT threads allow conductors to be installed in threaded boxes.
- UL listed "raintight" and concrete encasement.
- UL Standard UL 514B, File Reference Number E164166
- NEMA Standard: FB-1
- UNSPEC: 30211709
- Simple installation starts by stripping back PVC jacket at the end of cable, loosen the nut, slip cable into the connector until cable is fully inserted, then tighten the connector nut.

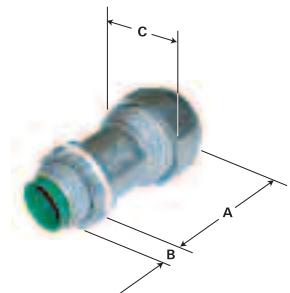

Connector Dimensions

☆ Fits sizes 1/2 - 10/3
 ☆☆ Fits sizes 10/4 - 8/3

Product Codes, Thread Sizes, Packaging, Weights & Dimensions

Catalog Number	Product Code	Thread Size (in)	Unit Quantity	Standard Package	Weight/C Pounds	Dimension A	Dimension B	Dimension C
☆ AFC595-U	0124-15-00	1/2" Connector	15	60	11.7	1-3/4"	17/32"	1-7/32"
☆ AFC595-I	0125-15-00	1/2" Insulated Connector	15	60	11.7	1-3/4"	17/32"	1-7/32"
☆☆ AFC596-U	0126-15-00	1/2" Connector	15	60	16.5	1-3/4"	17/32"	1-9/32"
☆☆ AFC596-I	0127-15-00	1/2" Insulated Connector	15	60	16.5	1-3/4"	17/32"	1-9/32"

Note: 90° Parking Deck/Lot Cable connectors: 895U uninsulated throat and 895I insulated throat available upon request. All dimensions and weights are subject to normal manufacturing tolerances.

See page 26 for details on Parking Deck Cables.

For the Newest AFC Fittings Catalog visit our website at www.afcweb.com, or call 800-757-6996



AFC's Custom Armoring Options

AFC offers a wide range of custom armoring options to suit a variety of application specific needs. Custom Armoring Services from AFC gives you better field performance by adding a layer or more with protective armors. Whether the application calls for power or fiber optic armor protection, electrical distribution or data applications, AFC is ready to service your requirements.

AFC's Custom Armoring Services provide steel strength protection and more. We can extrude color coded non-metallic coverings for moisture

protection, plenum and riser environments and/or extremes in temperature, along with the mechanical strength of steel. Whatever your requirements may be, AFC is ready with quick lead times and quality.

AFC delivers and is dedicated to providing improved field productivity, minimized down times and easy cable identification.

Call today to find out about AFC's Custom Armoring Services – 508-985-1233

AFC

CPID CABLE PROTECTION

CPID™ refers to AFC's process of adding a protective inter-locking armor to customer supplied core (wire, cable or fiber optic).

As an option, an outer jacket of specially formulated PVC can be added to provide further protection.

CPID can often eliminate the costly and time consuming process of installing cable into conventional raceways.

Cables can be combined to further reduce installation costs



960 Flaherty Drive
New Bedford, MA 02745
PHONE / 508-998-1131
TOLL-FREE / 800-757-6966
www.afcweb.com



UNISTRUT®

Columbia-MBF™

KAF-TECH™



UNISTRUT
CONSTRUCTION

GEM
WIRE & CONDUIT



TECTRON™
TUBE